

Naza - M V2

Quick Start Guide v1.28

2015.06.12 Revision

For Firmware Version V4.04 or above

& Assistant Software Version V2.40 or above

Thank you for purchasing this DJI product. Please strictly follow these steps to mount and connect this system on your aircraft, as well as to install the Assistant Software on your computer.

Please regularly check the web page of corresponding product* at our website www.dji.com, which is updated regularly. Product information, technical updates and manual corrections will be available on this web page. Due to unforeseen changes or product upgrades, the information contained in this manual is subject to change without notice.

* **Important:** Naza-M, Naza-M V2 and PHANTOM control system are different in hardware parts, but their configurations and functions are the same when using the same Assistant Software and Firmware Version, so they use the same Guide. Unless stated, the following instruction is basic on Naza-M V2. If you use the Naza-M, please make sure to read the "Instruction of V1 (also known as Naza-M)" section; if you use the PHANTOM, download the other corresponding manuals on the PHANTOM web page.

This manual is only for basic assembly and configuration; you can obtain more details and advanced instructions when using the assistant software. To assure you have the latest information, please visit our website and download the latest manual and current software version.

If you have any problem that you cannot solve during usage, please contact your authorized dealer.

Index

INDEX	2
INSTRUCTION	3
DISCLAIMER & WARNING	3
TRADEMARK	4
CERTIFICATIONS	4
SYMBOL INSTRUCTION.....	4
ASSEMBLY & CONNECTION	5
STEP1 PORT DESCRIPTION	5
STEP2 ASSEMBLY & CONNECTION	6
ASSISTANT SOFTWARE INSTALLATION AND CONFIGURATION	7
STEP1 SOFTWARE AND DRIVER INSTALLATION	7
STEP2 CONFIGURATION BY ASSISTANT ON A PC	8
BASIC FLYING	10
CONTROL MODE KNOWLEDGE	10
START & STOP MOTOR KNOWLEDGE	10
STEP1 COMPASS CALIBRATION	12
STEP2 ASSEMBLY CHECKING LIST	13
STEP3 BEFORE FLIGHT	13
STEP4 FLYING TEST.....	14
ADVANCED FUNCTIONS	16
A1 FAILSAFE	16
A2 LOW-VOLTAGE ALERT.....	17
A3 INTELLIGENT ORIENTATION CONTROL (IOC) FLIGHT (WITH GPS MODULE).....	18
A4 RECEIVER ADVANCED PROTECTION FUNCTION	21
A5 FLIGHT LIMITS	22
APPENDIX	23
SPECIFICATIONS	23
MC/PMU FIRMWARE UPGRADE	24
LED DESCRIPTION	25
INSTRUCTION OF V1 (ALSO KNOWN AS NAZA-M)	26
V1 ASSEMBLY AND CONNECTION.....	26
V1 IS COMPATIBLE WITH THE PMU V2 (ACCESSORY OF NAZA-M V2)	26
V1 PORT DESCRIPTION.....	27
V1 SPECIFICATION	28
FAQ	29
ABNORMAL LED INDICATION LIST.....	29
FIX THE TBE (TOILET BOWL EFFECT) PROBLEM.....	29
SHOULD YOU FIND THE MULTI-ROTOR DOES NOT TRACK STRAIGHT IN FORWARD FLIGHT.	30
MOTORS START FAILURE CAUSED BY TX STICK(S) MID-POINT ERROR TOO BIG	30
ATTITUDE CONTROLLABLE WHEN ONE MOTOR OUTPUT IS FAILED.....	31
WHEN USED WITH OTHER DJI PRODUCTS	31

Instruction

Disclaimer & Warning

Please read this disclaimer carefully before using the product. By using this product, you hereby agree to this disclaimer and signify that you have read them fully. THIS PRODUCT IS NOT SUITABLE FOR PEOPLE UNDER THE AGE OF 18.

This product is an autopilot system designed for serious multi-rotor enthusiasts providing excellent self-leveling and altitude holding, which completely takes the stress out of flying RC multi-rotors for both professional and hobby applications. Despite the system having a built-in autopilot system and our efforts in making the operation of the controller as safe as possible when the main power battery is connected, we strongly recommend users to remove all propellers when calibrating and setting parameters. Make sure all connections are good, and keep children and animals away during firmware upgrade, system calibration and parameter setup. DJI Innovations accepts no liability for damage(s) or injuries incurred directly or indirectly from the use of this product in the following conditions:

1. Damage(s) or injuries incurred when users are drunk, taking drugs, drug anesthesia, dizziness, fatigue, nausea and any other conditions no matter physically or mentally that could impair your ability.
2. Damage(s) or injuries caused by subjective intentional operations. Any mental damage compensation caused by accident.
3. Failure to follow the guidance of the manual to assemble or operate.
4. Malfunctions caused by refit or replacement with non-DJI accessories and parts.
5. Damage(s) or injuries caused by using third party products or fake DJI products.
6. Damage(s) or injuries caused by mis-operation or subjective mis-judgment.
7. Damage(s) or injuries caused by mechanical failures due to erosion, aging.
8. Damage(s) or injuries caused by continued flying after low voltage protection alarm is triggered.
9. Damage(s) or injuries caused by knowingly flying the aircraft in abnormal condition (such as water, oil, soil, sand and other unknown material ingress into the aircraft or the assembly is not completed, the main components have obvious faults, obvious defect or missing accessories).
10. Damage(s) or injuries caused by flying in the following situations such as the aircraft in magnetic interference area, radio interference area, government regulated no-fly zones or the pilot is in backlight, blocked, fuzzy sight, and poor eyesight is not suitable for operating and other conditions not suitable for operating.
11. Damage(s) or injuries caused by using in bad weather, such as a rainy day or windy (more than moderate breeze), snow, hail, lightning, tornadoes, hurricanes etc.
12. Damage(s) or injuries caused when the aircraft is in the following situations: collision, fire, explosion, floods, tsunamis, subsidence, ice trapped, avalanche, debris flow, landslide, earthquake, etc.
13. Damage(s) or injuries caused by infringement such as any data, audio or video material recorded by the use of aircraft.
14. Damage(s) or injuries caused by the misuse of the battery, protection circuit, RC model and battery chargers.
15. Other losses that are not covered by the scope of DJI Innovations liability.

Trademark

DJI and Naza-M are registered trademarks of DJI Innovations. Names of product, brand, etc., appearing in this manual are trademarks or registered trademarks of their respective owner companies. This product and manual are copyrighted by DJI Innovations with all rights reserved. No part of this product or manual shall be reproduced in any form without the prior written consent or authorization of DJI Innovations. No patent liability is assumed with respect to the use of the product or information contained herein.

Certifications

This product is approved with quality standards such as CE, FCC and RoHS.

Symbol Instruction



Forbidden(Important)



Cautions



Tip



Reference

Assembly & Connection

In the Box:

Main controller X1, PMU X1, GPS X1, GPS Bracket X1, LED X1, Servo Cable X8, Micro-USB Cable X1, 3M Adhesive Tape.

Step1 Port Description

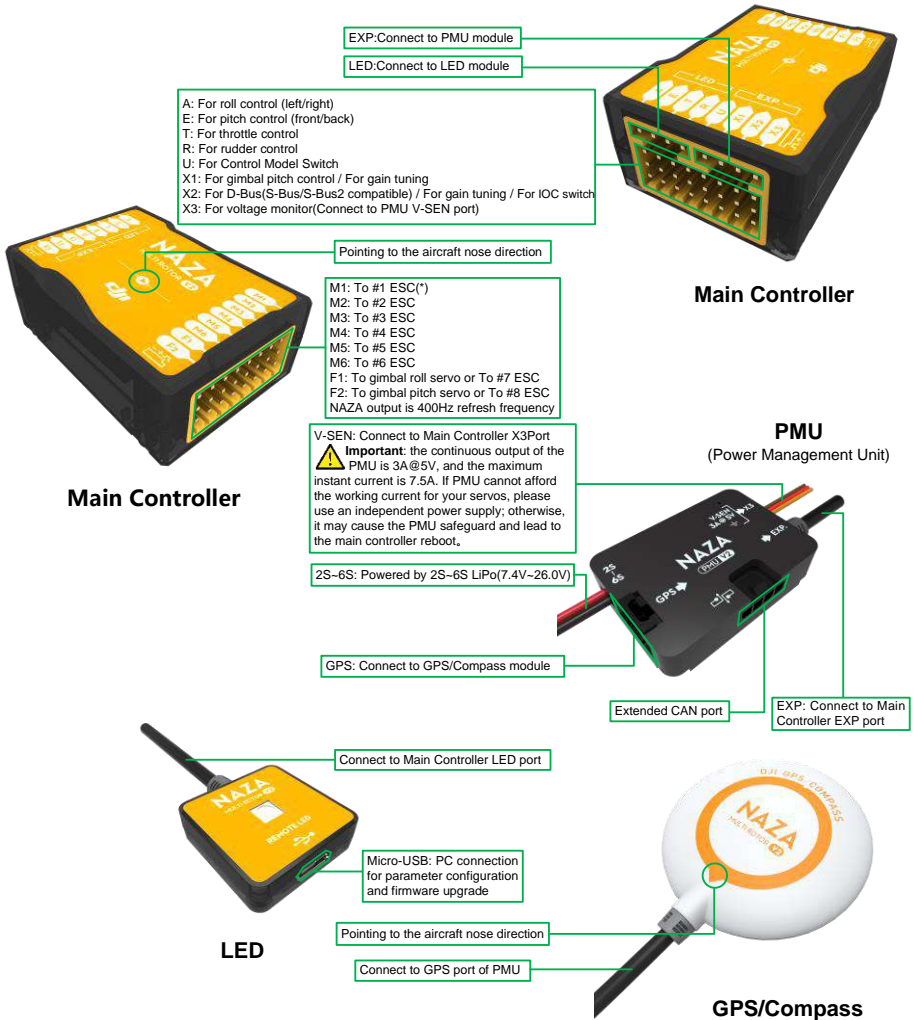

*ESC: Electronic Speed Controller

Assistant Software Installation and Configuration

Step1 Software and Driver Installation

Installing and running on Windows

1. Please download the driver and the Assistant installation software in **EXE** format from www.dji.com.
2. Switch on the transmitter and then power on your autopilot system.
3. Connect your autopilot system and PC via a Micro-USB cable.
4. Open the driver installation software and follow the instructions to complete installation.
5. Run the Assistant installation software and follow the instructions to complete installation.



The installer in EXE format is supported on Win XP, Win7, Win8 (32 or 64 bit).

Installing and running on Mac OS X

1. Download the Assistant installer in **DMG** format from the download page of NAZA-M V2 on the DJI website.
2. Run the installation software and follow the prompts to finish installation.



3. **When launching for the first time** if use Launchpad to run the NAZA-M V2 Assistant Software, Launchpad won't allow access because the software has not been reviewed by Mac App Store.

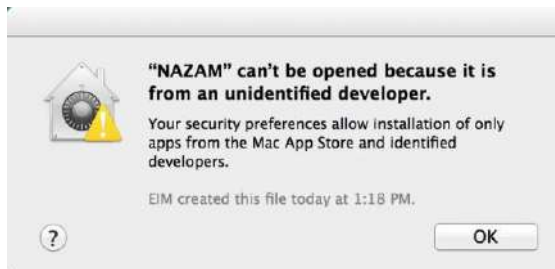

4. Locate the NAZA-M V2 icon in the Finder and open the file by Control or right clicking the icon and selecting “Open” from the menu.
5. After the first successful launch, double-clicking the NAZA-M V2 icon in the Finder or using Launchpad will open the application.

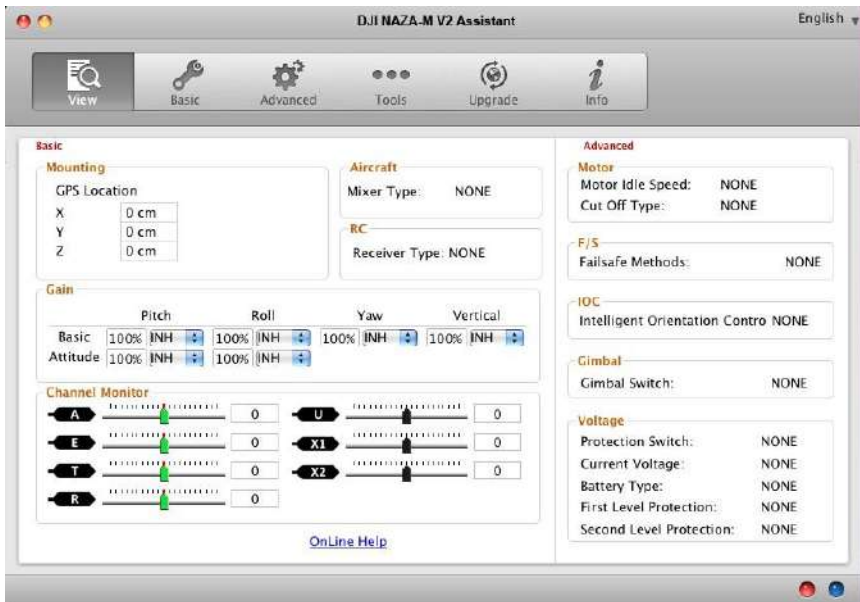



Installer in DMG format is supported on Mac OS X 10.6 or above.



The NAZA-M V2 Assistant on Mac OS X and Windows are exactly the same. The Assistant appear in other places of this manual is based on Windows version.

Step2 Configuration by Assistant on a PC

1. Power on the PC. Make sure your computer is connected to the Internet for the first time you use.
2. Switch on the transmitter first, and then power on the autopilot system. Connect the autopilot system to the PC with a Micro-USB cable. DO NOT break the connection until setup is finished.
3. Run the Assistant Software.
4. Observe the indicators on the left bottom of the software. (  They are the connection indicator and communication indicator in order.) If the communication indicator is blinking, that the software is ready, please go to next step.
5. Select the “Info” option. Check the software firmware version. If the upgrade is available, you may update the assistant software.

6. Select the “Upgrade” option. Check the Main Controller, GPS and IMU firmware version.
7. Select the “Basic” option. Please follow step-by-step for your first-time-configuration. Basic configuration is necessary, including Mixer Type, Mounting, RC, and Gain settings.
8. You can click the “Advanced” option for more parameter settings. Advanced setting is optional. There are settings of Motor, FailSafe, Intelligent Orientation Control (IOC), Gimbal, Low-Voltage Alert, and Flight Limits. Read the instruction in the assistant software to obtain more details.
9. Select the “Viewer” option to check all parameters.
10. Then break the Micro-USB cable, power off the aircraft. Finished.



- (1) You may be required to fill register information for your first-time-usage.
- (2) If the communication indicator is blue on, please double check the connections.
- (3) Basic configuration is necessary before you go to the “Basic Flying Test”.
- (4) Users are required to install a Windows system, since the software can only run on Windows system .



- (1) If the firmware upgrade is available, please upgrade it by referring to the Firmware Upgrade in the Appendix.
- (2) This step is required to use together with the assistant software to obtain more details.

Configuration Information

Aircraft	Configuration Information				
	Motor	ESC	Propeller	Battery	Weight
S900	DJI-4216	DJI-40A	Z-BLADE-17 × 6.0 Inch	6S-12000	6800g
F450	DJI-2312	DJI-20A	Z-BLADE-9.4 × 5.0 Inch	4S-5000	890g
F550	DJI-2312	DJI-20A	Z-BLADE-9.4 × 5.0 Inch	4S-5000	1530g

Recommended Parameters

Aircraft	Basic Gain				Attitude Gain		Max Angular Rate	
	Pitch	Roll	Yaw	Vertical	Pitch	Roll	Pitch	Roll
S900	100	100	100	100	160	160	220	220
F450	95	95	70	100	100	100	300	300
F550	110	100	80	100	100	100	300	300

Basic Flying

Control Mode Knowledge

Please read the Control Mode Knowledge clearly before usage, to know how to control the aircraft.

Different control modes will give you different flight performances. Please make sure you understand the features and differences of the three control modes.

	GPS ATTI. Mode (With GPS Module)	ATTI. Mode	Manual Mode
Rudder Angular Velocity	Maximum rudder angular velocity is 150°/s		
Command Linearity	YES		
Command Stick Meaning	Multi attitude control; Stick center position for 0° attitude, its endpoint is 35°.		Max-angular velocity is 150°/s. No attitude angle limitation and vertical velocity locking.
Altitude Lock	Maintain the altitude best above 1 meter from ground.		NO
Stick Released	Lock position if GPS signal is adequate.	Only attitude stabilizing.	NOT Recommend
GPS Lost	When GPS signal has been lost for 3s, system enters ATTI. Mode automatically.	Only performing attitude stabilizing without position lock.	---
Safety	Attitude & speed mixture control ensures stability		Depends on experience.
	Enhanced Fail-Safe(Position lock when hovering)	Auto Level Fail-Safe (Attitude stabilizing)	
	With GPS/Compass module and the failsafe requirements are satisfied, in each Control Mode (including GPS Mode, ATTI. Mode, Manual Mode and IOC Mode), the aircraft will enter the failsafe Mode.		
Applications	AP work	Sports flying.	---

Start & Stop Motor Knowledge



- (1) Both Immediately Mode and Intelligent Mode are available in the Assistant Software: Advanced->Motor->Stop Type.
- (2) Stop Motor method is defaulted to Immediately Mode.

Please get to know well about this section before flying.

- 1 **Start Motor:** Pushing throttle stick before takeoff will not start the motors. You have to execute any one of following four Combination Stick Commands (CSC) to start the motors:



2 Stop Motor: We provide two options to stop motors in the assistant software: Immediately and Intelligent.

- (1) **Immediately Mode:** If you select this mode, in any control mode, once motors start and throttle stick is over 10%, motors will not stop immediately only when throttle stick is back under 10% the motors will stop. In this case, if you push the throttle stick over 10% within 5 seconds after motors stop, motors will re-start, CSC is not needed. If you don't push throttle stick after motors start in three seconds, motors will stop automatically.
- (2) **Intelligent Mode:** By using this mode, different control mode has different way of stopping motors. In Manual Mode, only executing CSC can stop motors. In ATTI. Mode or GPS ATTI. Mode, any one of following four cases will stop motors:
 - a) You don't push throttle stick after motors start within three seconds;
 - b) Executing CSC;
 - c) Throttle stick under 10%, and after landing for more than 3 seconds.
 - d) If the angle of multi-rotor is over 70°, and throttle stick under 10%.

Notes of Intelligent Mode



- (1) In ATTI. / GPS ATTI. Mode, it has landing judgment, which will stop motors.
- (2) Start motors in ATTI. / GPS ATTI. Mode, you have to execute CSC and then push throttle stick over 10% in 3 seconds, otherwise motors will stop after 3 seconds.
- (3) During normal flight, only pull throttle stick under 10% will not stop motors in any control mode.
- (4) For safety reason, when the slope angle of multi-rotor is over 70° during the flight in ATTI. / GPS ATTI. Mode (may be caused by collision, motor and ESC error or propeller broken down), and throttle stick is under 10%, motors will stop automatically.

Notes of Intelligent Mode & Immediately Mode



- (1) If you choose the Immediately Mode, you should not pull throttle stick under 10% during flight, because it will stop motors. If you do it accidentally, you should push the throttle stick over 10% in 5s to re-start motors.
- (2) DO NOT execute the CSC during normal flight without any reason, or it will stop motors at once.



- (1) If you choose the Intelligent mode, and the throttle stick is under 10%, this will trigger the landing Procedure, in any control mode. In this judgment, pitch, roll and yaw controls are denied except the throttle, but multi-rotor will still auto level.
- (2) In any control mode, DO NOT pull throttle stick under 10% during normal flight without any reason.



- (1) Any of these two cut off types will only work properly if TX calibration is correct done.
- (2) In failed-safe, CSC is denied by the main controller, motors will hold their state.

Step1 Compass Calibration

Without GPS module, please skip this step. If you use with GPS module, follow step-by-step for calibration.



- (1) DO NOT calibrate your compass where there is magnetic interference, such as magnetite, car park, and steel reinforcement under the ground.
- (2) DO NOT carry ferromagnetic materials with you during calibration, such as keys or cell phones.
- (3) Compass module CANNOT work in the polar circle.
- (4) Compass Calibration is very important, otherwise the system will work abnormal.

Calibration Procedures

1. Switch on the transmitter, and then power on autopilot system!
2. Quickly switch the control mode switch from **GPS Mode** to **Manual Mode** and back to **GPS Mode** (or from **GPS Mode** to **ATTI. Mode** and back to **GPS Mode**) for more than 5 times, The LED indicator will turn on constantly yellow so that the aircraft is ready for the calibration.
3. (Fig.1) Hold your Multi-rotor horizontal and rotate it around the gravitational force line (about 360°) until the LED changes to constant green, and then go to the next step.
4. (Fig.2) Hold your Multi-rotor vertically and rotate it (**its nose is downward**) around the gravitational force line (about 360°) until the LED turns off, meaning the calibration is finished.

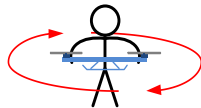

Fig.1

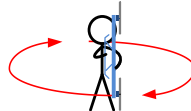



Fig.2

5. If the calibration was successful, calibration mode will exit automatically. If the LED keeps flashing quickly Red, the calibration has failed. Switch the control mode switch one time to cancel the calibration, and then re-start from step 2.



- (1) When the GPS is abnormal, the Main controller will tell you by the LED blinking Red and Yellow alternately (), disable the GPS Module, and automatically enter the aircraft into the ATTI. Mode.
- (2) You don't need to rotate your multi-rotor on a precise horizontal or vertical surface, but keep at least 45° difference between horizontal and vertical calibration.
- (3) If you keep having calibration failure, it might suggest that there is very strong magnetic interference around the GPS /Compass module, please avoid flying in this area.
- (4) When to do re-calibration
 - a) The flight field is changed.
 - b) When the multi-rotor mechanical setup has changed:
 - If the GPS/Compass module is re-positioned.
 - If electronic devices are added/removed/ re-positioned (Main Controller, servos, batteries, etc.).
 - When the mechanical structure of the multi-rotor is changed.

- c) If the flight direction appears to be shifting (meaning the multi-rotor doesn't "fly straight").
- d) The LED indicator often indicates abnormality blinking when the multi-rotor spins. (It is normal for this to happen only occasionally)

Step 2 Assembly Checking List

Please check each item, to make sure for safety.

Any of the following mistakes will lead to a dangerous accident, double check all these items:





- (1) Rotation direction of motor is opposite
- (2) Infirm connection between the motor and the ESC
-  (3) Wrong or infirm installation of Main controller
- (4) Wrong or infirm connection between the main controller and ESC.
- (5) Propeller installation mistake
- (6) Magnetization of the compass

Make sure the following items are correct.

-  (1) Make sure you have assembled your multi-rotor correctly.
- (2) Make sure you have done the configuration procedure correctly.
- (3) Make sure all connections are in good condition.
- (4) Make sure batteries are fully charged for your transmitter, autopilot system and all devices.

Step 3 Before Flight

Carry out the following procedures (is based on Intelligent Mode of Motor Stop) to make sure all configurations are correct. Refer to the Appendix->LED Description for more LED details.

1. Always switch on the transmitter first, then power on multi-rotor!
2. Keep the aircraft stationary until the system start and self-check has finished (). After that, the LED may blink Yellow 4 times quickly (). Start motor is disable during LED blinking Yellow 4 times quickly (), as the system is warming up.
3. After the 4 times Yellow LED disappears, toggle the control mode switch on your transmitter to make sure it is working properly. For example, LED blinks (), which means the system is in ATTI. Mode and the GPS signal is worst Check it with LED indicator to specify the current working mode for MC. See following table for details about LED indicator;
 - (1) There are Manual Mode and ATTI. Mode without a GPS/Compass module, no GPS signal status LED indicator.
 - (2) After connecting to the GPS/Compass module, GPS ATTI. Mode is available, and GPS signal status LED indicator is available.

Control Mode LED Indicator	GPS Signal Status LED Indicator
Manual Mode: NO LED	Signal is best (GPS satellites > 6) : NO LED
ATTI. Mode: ● (●● indicates that is stick(s) not at center)	Signal is well (GPS satellites = 6) : ●
GPS Mode: ● (●● indicates that is stick(s) not at center)	Signal is bad(GPS satellites = 5) : ●●
	Signal is worst (GPS satellites < 5) : ●●●

- Keep the aircraft stationary, and then push both sticks to the left bottom or right bottom (shown as the following chart, defined as Combination Stick Commands (CSC)), to start the motors.



- Release the yaw, roll and pitch sticks and keep them at the mid point, and the throttle stick under the mid point. Then check whether all propellers are rotating correctly.
- Stop motors, power off the Multi-rotor.
- Make sure all settings and configurations are correct and then you can take off you aircraft.

After power on, if abnormal LED Indicator occurs, please refer to the Abnormal LED instruction in the FAQ and aids troubleshooting.

Step4 Flying Test

- Choose an open space without obstruction, tall buildings and crowds as flying filed. Place the aircraft 3 meters away from you and others, to avoid accidental injury.
- If in GPS ATTI. Mode, place the aircraft in an open space without buildings or trees. Take off the aircraft after 6 or more GPS satellites are found (Red LED blinks once or no blinking). If in Manual Mode or ATTI. Mode, you can skip this step.
- Start-up
 - Switch on the transmitter first, then power on multi-rotor! Keep the aircraft stationary until the system start and self-check has finished.
 - Please wait for the system to warm up gradually with the LED blinks Yellow 4 times quickly (●●●●). You should not start the motors until the blinking disappears.
 - Keep the aircraft stationary, and execute the CSC to start the motors.
 - Release the yaw, roll and pitch sticks and keep them at the mid point, at the same time raise the throttle stick from the bottom. The motors will stop if you do not push the throttle stick from the bottom within 3 sec and you will need to re-start the motors.
 - Keep raising the throttle stick until all the rotors are working, push the throttle stick to the mid point and then take-off your multi-rotor gently, pay attention not to push the stick excessively.

- (6) Pay attention to the aircraft movement at any time when flying, and use the sticks to adjust the aircraft's position. Keep the yaw, roll, pitch and throttle sticks at the mid point to hover the aircraft at the desired height.
4. Lower the aircraft slowly. Pull the throttle stick to the bottom and then execute the CSC to stop the motors after landing.
5. Please always power off the Multi-rotor first, and then switch off the transmitter after landing.

FLYING NOTES(VERY IMPORTANT) !!!

- (1) If the warm up waiting is longer than 2 minutes (the 4 times Yellow blink continues), please power off for 10 minutes, cold start, and then connect the assistant software, enter the "Tools" -> IMU calibration, carry out the Advanced calibration.
- (2) If you enable the Immediately Mode of Motor Stop; you should not pull throttle stick under 10% during flight, because it will stop motors. If you do it accidentally, you should push the throttle stick over 10% in 5s to re-start motors.
- (3) DO NOT execute the CSC during normal flight without any reason, or it will stop motors at once.
- (4) Pay attention to the GPS satellite status LED indicator. Bad GPS signal may lead the aircraft to drift when hovering.
- (5) DO NOT fly near to ferromagnetic substances, to avoid strong magnetic interference with the GPS.
- (6) Please avoid using GPS ATTI. Mode in the areas, where GPS signal is most likely bad.
- (7) If the LED flashes quickly Red then this indicates battery voltage is low, land ASAP.
- (8) If the transmitter indicates low-battery alarm, please land ASAP. In this condition the transmitter may cause the aircraft to go out of control or even crash.
- (9) In GPS ATTI. Mode, make sure that the home point is recorded when the GPS signal is well; otherwise the home point recording may be not so precise.



- (1) In ATTI Mode, throttle stick center position is for 0m/s along the vertical direction. You should keep the position of throttle stick higher than 10% from cut-throttle during the flight! In any control mode, DO NOT pull throttle stick under 10% during normal flight without any reason.
- (2) It is recommended to land the aircraft slowly, to prevent the aircraft from damage when landing.
- (3) If Low-Voltage Alarm is set, the aircraft will act according to the configuration of the Assistant Software once Low-Voltage Alarm is triggered. Make sure you remember what you have set before.
- (4) If Fail-Safe function is set, the aircraft will act according to the configuration of the Assistant Software once Fail-Safe is triggered. Make sure you remember what you have set before.



Advanced Functions

A1 FailSafe

An introduction of Go-Home and Landing.

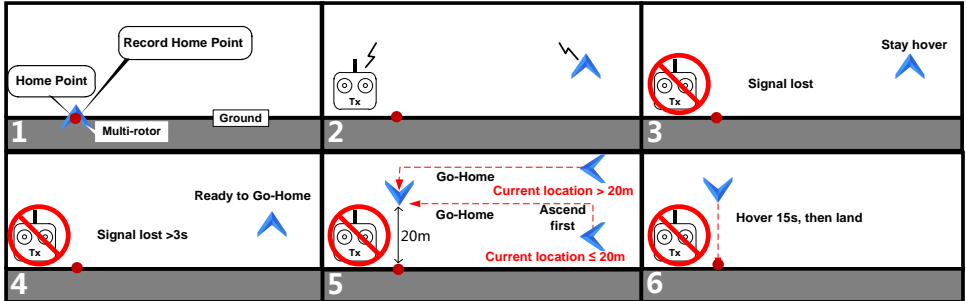

Home-point: Before takeoff, current position of multi-rotor will be saved as home-point by MC automatically when you start the motors for the first time after 6 or more GPS satellites are found (red light blinks once or no blinking) for 10 seconds.

- (1) Please make sure to record the home-point before takeoff, and clearly know where it is.
- (2) During go-home the nose direction of the aircraft is facing toward the home-point, the aircraft is flying directly from the current position to the home-point.
- (3) You can regain the control during the aircraft is hovering 15 seconds.

The flowchart of failsafe and how to regain control

This section will demonstrate the working logic of failsafe and how to regain control. The following description is effective only when:

1. The aircraft is in flight.
2. The GPS works normally and signal is good (≥ 6 satellite, the LED blinks a single red light or no red light).

- What triggered failsafe
- The aircraft behavior after failsafe
- How to regain control
- Precautions

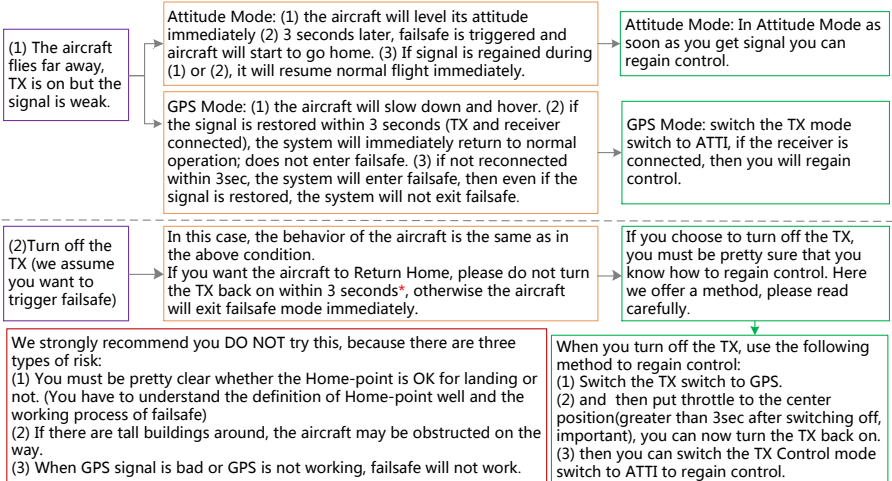

Note: if you start the motors, but do not push the throttle to take-off the aircraft, in this case it is very dangerous to turn off the TX, because the aircraft will take off automatically, so do not try this.

* If signal lost for more than 3 seconds failsafe will be triggered, if signal regained within 3 seconds it will exit failsafe immediately.

A2 Low-Voltage Alert

In order to prevent your multi-rotor from a crash or other harmful consequences caused by low battery voltage, there are two levels of low voltage protection available to use. You can choose to use or not to use them; however we strongly recommend using the protections if available! Low-Voltage Alert is to indicate that the battery cannot provide enough power for the aircraft, in order to warn you to land the aircraft ASAP. You can configure this function in the assistant software, and please read the text in the software carefully before your flight. Make sure to carry out the Current Voltage Calibration.

There are both first level and second level protections. The first level protection has LED warning. During second level protection the aircraft will land automatically with LED warning. Meanwhile the center point of throttle stick will move up slowly to 90% of endpoint, you should land ASAP to prevent your aircraft from crashing!

It is not for fun, you should land your aircraft ASAP to prevent your aircraft from crashing or other harmful consequences!!!



- (1) Configure the FailSafe function in the **assistant software** -> **“Advanced”** -> **“F/S”** and read the instruction thoroughly and carefully.
- (2) Configure the Low-Voltage Alert function in the **assistant software** -> **“Advanced”** -> **“Voltage”** and read the instruction thoroughly and carefully.

A3 Intelligent Orientation Control (IOC) Flight (with GPS module)

Definition of Forward Direction:

Multi-rotor will fly along this direction when you push the elevator stick (→).

Step 1/Before You Start

Usually, the forward direction of a flying multi-rotor is the same as the nose direction. By using IOC, wherever the nose points, the forward direction has nothing to do with nose direction. The red and blue arrows on the transmitter are corresponding to pitch and roll operations in the following diagram.

- In course lock flying, the forward direction is the same as a recorded nose direction. All the following requirements are met: the autopilot system is in ATTI. Mode or GPS ATTI. Mode.

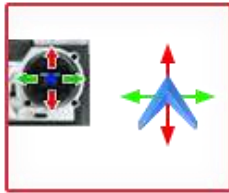

Normal flying

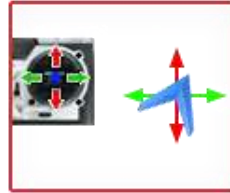

Course Lock Flying

- In home lock flying, the forward direction is the same as the direction from home point to multi-rotor. All the following requirements are met: 6 or more GPS satellites are found, in GPS ATTI. Mode, and the aircraft is further than 10m away from the home point.



Normal flying

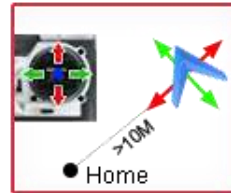

Home Lock Flying

Step 2/IOC Switch Setting

Before using the IOC function, you have to choose a 3-position switch on your transmitter as the IOC switch, which is also used for recording the orientation, home position in corresponding modes. Refer to the assistant software; click the "Advanced" to find the "IOC".

IOC Switch			
IOC Function	OFF	Course Lock	Home Lock



The above table is for example. The function of the switch position may be reversed since the normal/reversed setting of the switch channel. Toggle the switch and observe the slider position of channel X2 on the assistant software screen, the corresponding area should turn blue.

Step 3 Method of Forward Direction and Home Point Recording

If you use the IOC function, **please be aware of the Forward Direction of Course Lock Flying, and the home point of Home Lock Flying.** There are two ways to record the forward direction and the home point: Manually and Automatically. You may choose any one record method. The LED will blink Green quickly if successfully recorded.

	Course Lock	Home Lock
Automatically	30 seconds after you power on the autopilot system.	Before takeoff, the current position of the aircraft will be saved as home point when you start the motors for the first time after 6 or more GPS satellites have been found for 10 seconds.
Manually	30 seconds after you power on the autopilot system. Toggle the IOC switch from Off to Course Lock, and back to Off quickly 3 to 5 times.	After 6 or more GPS satellites have been found. And the aircraft can be hovering. Toggle the IOC switch from Course Lock to Home Lock, and back to Course Lock quickly 3 to 5 times.



DO NOT toggle the switch between Off to Home Lock, since it may change the recording of the **Forward Direction of Course Lock.**

Step 4 IOC Flying Test

Then you can do **Course Lock and Home Lock flying test.**

Carry out an IOC flight by the following procedure. The Control Mode LED will blink Yellow and Green alternatively (●●) to indicate the IOC mode only when the main controller is really to fly in Course Lock, Home Lock modes.

During the same flight	STEP1: Record	STEP2: ON	STEP3: OFF	STEP4: ON again
Course Lock				
Switch Setting	Record the Forward Direction	Set Control Mode switch at GPS or ATTI position, Toggle IOC switch from OFF to Course Lock position	Toggle IOC switch to OFF position	Toggle IOC switch from OFF to Course Lock position
Home Lock				
Switch Setting	Record the Home Point	Set Control Mode switch at GPS position, Toggle IOC switch from OFF to Home Lock position	Toggle IOC switch to OFF position	Toggle IOC switch from OFF to Home Lock position

Aircraft moving direction when pull pitch stick Aircraft moving direction when pull roll stick

● Home point > Aircraft (the arrow is pointing to the direction of the aircraft nose)

IOC FLYING NOTES !!!







- (1) When Multi-rotor is flying by home lock far away from you and the home point, please DO NOT toggle the IOC switch many times quickly so as to avoid the change of home point without your attention.



- (1) Home lock flying requires that 6 or more GPS satellites are found and the aircraft is further than 10m away from the home point.
- (2) If the IOC flying requirement is not satisfied, the autopilot system will quit IOC control mode. Please be aware of the LED indicator, to know the current control mode of the autopilot system.



- (1) Blinking indications of IOC  are:
 - a) Before motors start:  blink, all sticks (except throttle stick) return to center;  blink, stick(s) (except throttle stick) not at center.
 - b) After motors start and throttle stick is over 10% in 3 seconds:  blink, all sticks return to center;  blink, stick(s) not at center.
- (2) Before you do the home lock flight, you have to fly the aircraft out of the 10m range around home point, and then flip the IOC switch to Home Lock position to fly in home lock when all the requirements are met. If you have already toggled the IOC switch to Home Lock position when the aircraft is still in 10m range around home point, and this is the first time you are going to fly in home lock during the current flight, then if all the requirements are met, the main controller will change into home lock automatically when Multi-rotor flies out the 10m range around home point.
- (3) When flying in Home Lock mode, if any of the following situations happen, then the system will quit Home Lock flying and automatically enter Course Lock flying. The aircraft will fly in Course Lock using the earlier forward direction.
 - a) The aircraft fly 's within 10m range of the home point.
 - b) You toggle the control mode switch to the ATTI. Mode.
 - c) The GPS signal becomes bad (The GPS signal LED is blinking Red twice or three times).
- (4) We suggest that you should know clearly which flight lock method you are going to fly, and you know the locked forward direction or home point, before you switch on IOC mode during the flight.

A4 Receiver Advanced Protection Function

You are asked to enable this function by connecting to the Assistant Software, please set it at the section of Basic->R/C-> Receiver Advanced Protection.

If you choose enable it, the FailSafe will be triggered if the following situations occur during flight.

According to the difference of the aircraft height, there are two situations.

1. Lower than 100m, the A/E/R channel is not at the mid point.
2. Higher than 100m, the A/E/R channel is not at the mid point or the throttle stick is above the mid point.

In the GPS Mode or ATTI. Mode, if the requirement a) or b) is satisfied, and the output data of four channels A/E/R/T have not changed for 20 seconds, then the aircraft will hover automatically. After that, if the output data of four channels A/E/R/T still do not any changes and last for 10 seconds, the autopilot system will think that the data from receiver is abnormal, and then enter the FailSafe Mode.

Brief introduction of how to quit the FailSafe Mode

If there is any command change from the receiver, the autopilot system thinks that the receiver is regained. In ATTI. Mode and Manual Mode, it will quit the FailSafe Mode automatically. In GPS Mode, please toggle the control mode switch to the ATTI. Mode and Manual Mode position to regain the control. Refer to the FailSafe section for more details.

A5 Flight Limits

The flight limits function is default enabled in the NAZA-M Flight control system, it's aimed to restrict the flying height and distance of the aircraft. The Max Height restricts the vertical distance between the aircraft and the Home point, the Max Radius restricts the horizontal distance between the aircraft and the Home point.

The default Max Height is 2000m and Max Radius is 2000m. Users can write the values of the Max Height and Max Radius in the Assistant software, the range of the Max Height is 10m-100000m, the range of the Max Radius is the same. So that the aircraft will fly in the entered range, which is a cylinder space above the Home point.

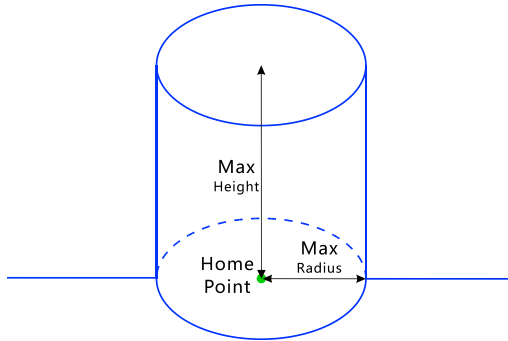

- (1) Height Limit works when the control mode is GPS or ATTI. Mode. Radius Limit works when the control mode is GPS and the satellite number ≥ 6 .
- (2) If the aircraft flies out of the limits, it's still controllable except flying further away.
- (3) If the control mode is changed to GPS when the aircraft is out of Max Radius, the aircraft will fly back within the entered range.
- (4) The Failsafe and the Ground Station operations are not restricted to the Flight Limits.

Appendix

Specifications

General	
Built-In Functions	(1) Three Modes of Autopilot
	(2) Enhanced Fail Safe
	(3) Low Voltage Protection
	(4) S-Bus/S-Bus2 Receiver Support
	(5) PPM Receiver Support
	(6) 2-axle Gimbal Support
Peripheral	
Supported Multi-rotor	<ul style="list-style-type: none"> ● Quad-rotor I4, X4; ● Hexa-rotor I 6, X6, IY6, Y6. ● Octo-rotor I8, V8, X8
Supported ESC output	400Hz refresh frequency.
Recommended Transmitter	PCM or 2.4GHz with a minimum 4 channels.
Assistant Software System Requirement	Windows XP SP3; Windows 7; Windows 8
Electrical & Mechanical	
Working Voltage Range	<ul style="list-style-type: none"> ● MC: 4.8V ~ 5.5 V ● PMU Input: 7.4V ~ 26.0 V (recommend 2S ~ 6S LiPo) Output(V-SEN port red wire): 3A@5V Output(V-SEN port red wire)burst current:7.5A
Power Consumption	<ul style="list-style-type: none"> ● MAX: 1.5W(0.3A@5V) ● Normal: 0.6W(0.12A@5V)
Operating Temperature	-10 °C ~ 50 °C (14F ~122F)
Weight	<ul style="list-style-type: none"> ● MC: 27g ● GPS/Compass: 27g ● PMU: 28g ● LED: 13g
Dimensions	<ul style="list-style-type: none"> ● MC: 45.5mm × 32.5mm × 18.5mm ● GPS/Compass: 46mm (diameter) x 10mm ● PMU : 39.5mm × 27.5mm × 10.0mm ● LED : 25mm × 25mm × 7.0mm
Flight Performance (can be effected by mechanical performance and payloads)	
Hovering Accuracy (GPS Mode)	<ul style="list-style-type: none"> ● Vertical: ± 0.8m ● Horizontal: ±2.5m
Max Yaw Angular Velocity	200° /s
Max Tilt Angle	35°
Max Ascent / Descent Speed	Ascent : 6m/s, Descent : 4.5 m/s

MC/PMU Firmware Upgrade

Please follow the procedure for software and firmware upgrade; otherwise the system might not work properly. For SAFETY REASONS, DO NOT use power battery during firmware upgrade.

1. Make sure your computer is connected to the Internet.
2. Please close all the other applications during the firmware upgrade, including anti-virus software and firewall.
3. Make sure the power supply is securely connected. DO NOT un-plug the power supply until firmware upgrade has finished.
4. Connect system to PC with Micro-USB cable, DO NOT break connection until firmware upgrade is finished.
5. Run Software and wait for connection.
6. Select **Upgrade** option → Check the MC and PMU Firmware Version.
7. DJI server will check your current firmware version, and get the latest firmware prepared for the unit.
8. If there is a firmware version more up-to-date than your current version, you will be able to click to update them.
9. Wait until Assistant software shows "finished".
10. Click **OK** and power cycle the unit after at least 5 seconds.
11. Your unit is now up-to-date.



- (1) After firmware upgrade, please re-configure the system using Assistant software.
- (2) If firmware upgrade failed, the system will enter waiting for firmware upgrade status automatically, please try again with the above procedures.
- (3) Select **Upgrade** option → Check the GPS Firmware Version, online upgrade is disable.

LED Description

System Status	LED Flashing
System start and self-check	
IMU abnormal data or need advanced calibration*	
Warm up after power on	
The aircraft is moved or bias of sensors too big	
Compass error too big, need recalibration.	
Transmitter (TX) signal lost, enter the FailSafe.	
TX stick(s) mid point error too big	
Low voltage alert or other abnormal alert* (e.g. Configuration error, TX data error, Enable low voltage protection without PMU, SN error or Compass abnormal work.)	
Record forward direction or home point	
Control Mode Indicator	Manual Mode: None ATTI Mode: (stick(s) not at center) GPS Mode: (stick(s) not at center) IOC Mode: (stick(s) not at center)
GPS Signal State Indicator (GPS/Compass Module is necessary)	GPS Signal is Best(GPS Satellite number > 6): None GPS Signal is Well(GPS Satellite number = 6): GPS Signal is Bad (GPS Satellite number = 5) : GPS Signal is Worst (GPS Satellite number < 5):

Compass Calibration	LED Flashing
Begin horizontal calibration	
Begin vertical calibration	
Calibration or others error	

*You can figure out the error by connecting the autopilot system to the assistant software.

Instruction of V1 (also known as NAZA-M)

V1 (also known as NAZA-M) system is different from V2 system, if you are V1 system user, please read the following text carefully, and refer to the other text in this Guide for usage details (including **Assistant Software Configuration**, **Basic flying**, **Advanced Function Appendix** and **FAQ**, etc.) .

V1 Assembly and Connection

Connect the V1 system according to the following chart.

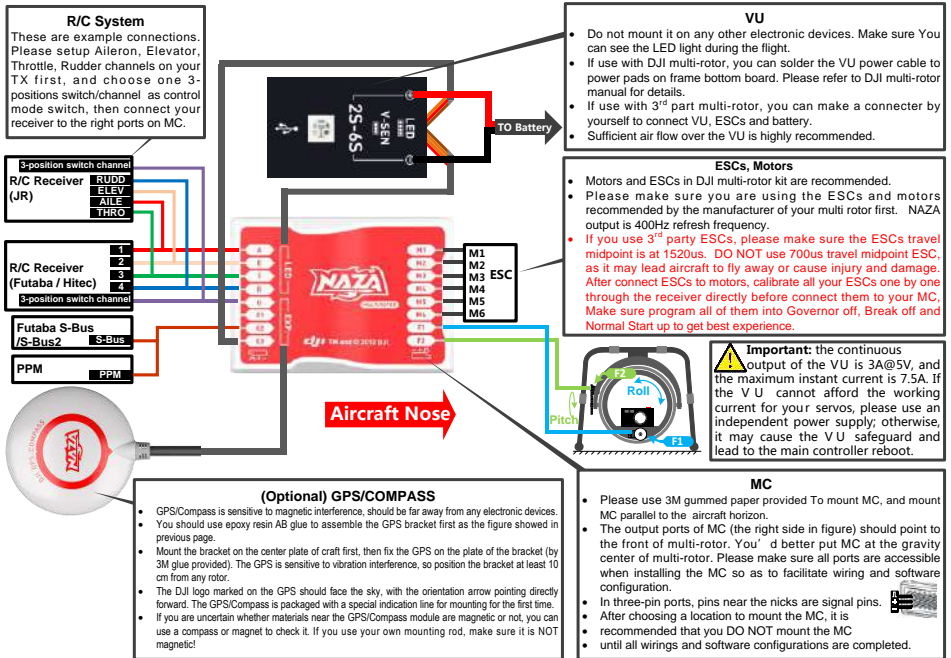

V1 is compatible with the PMU V2 (Accessory of Naza-M V2)





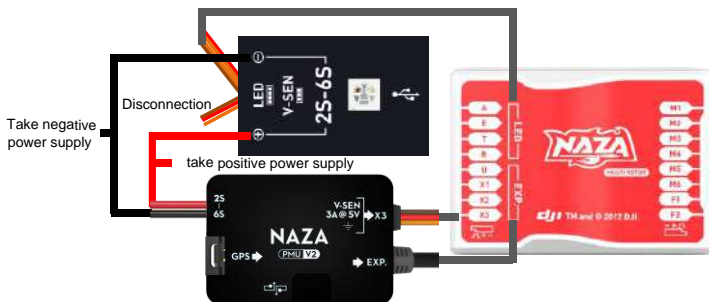













V1 system is compatible with the PMU V2 of V2 system; please carry out the following connection. The other modules connection is the same as before.

Important: You are asked to upgrade your Firmware version of V1 MC to V3.10 or above, as the PUM V2 can only work with the MC of version 3.10 or above.



VI Port Description

Please remember the function of each port, which may help you to use the Naza-M efficiently.

Main Controller		
	For roll control (left/right)	
	For pitch control (front/back)	
	For throttle control	
	For rudder control	
	For Control Mode Switch	
	For gimbal pitch control	Or for gain tuning
	For D-Bus (S-Bus/ S-Bus2 compatible)	Or for gain tuning Or for IOC switch
	For voltage monitor (Connect with VU V-SEN port)	
	To #1 rotor	
	To #2 rotor	
	To #3 rotor	
	To #4 rotor	
	To #5 rotor	
	To #6 rotor	
	To gimbal roll servo	Or to #7 rotor (Upgrade the MC Firmware to V3.10 or above)
	To gimbal pitch servo	Or to #8 rotor (Upgrade the MC Firmware to V3.10 or above)
	LED port, for LED wire connection from Versatile Unit	
	GPS port, for GPS module wire connection. (In three-pin ports, pins near the nicks are signal pins.)	
Versatile Unit		
V-SEN	V-SEN port: To the X3 port of the main controller, for monitoring battery voltage and supplying power <ul style="list-style-type: none">● Orange wire (signal wire) output: $\pm 3.3V$● Red wire (power wire) output: 3A@5V	
LED	LED wire, to LED port of the main controller.	
	USB port: PC connection for configuration and firmware upgrades.	
Optional GPS & Compass		
Connect to the EXP. port.		





V1 Specification

General	
Built-In Functions	<ul style="list-style-type: none">● Three Modes of Autopilot● Enhanced Fail Safe● Low Voltage Protection● S-Bus/ S-Bus2 Receiver Support● PPM Receiver Support● 2-axle Gimbal Support
Peripheral	
Supported Multi-rotor	<ul style="list-style-type: none">● Quad-rotor I4, X4;● Hexa-rotor I 6, X6, IY6, Y6.● Octo-rotor I8, V8, X8 (Upgrade the MC Firmware to V3.10 or above)
Supported ESC output	400Hz refresh frequency.
Recommended Transmitter	PCM or 2.4GHz with a minimum 4 channels.
Assistant Software System Requirement	Windows XP SP3; Windows 7
Electrical & Mechanical	
Working Voltage Range	<ul style="list-style-type: none">● MC: 4.8V ~ 5.5 V● VU Input: 7.2V ~ 26.0 V (recommend 2S ~ 6S LiPo) Output(V-SEN port red wire): 3A@5V Output(V-SEN port red wire)burst current:7.5A
Power Consumption	<ul style="list-style-type: none">● MAX: 1.5W(0.3A@5V)● Normal: 0.6W(0.12A@5V)
Operating Temperature	-10°C ~ 50°C(14F ~122F)
Weight	<ul style="list-style-type: none">● MC: 25g● GPS: 21.3g● VU: 20g
Dimensions	<ul style="list-style-type: none">● MC: 45.5mm × 31.5mm × 18.5mm● GPS & Compass: 46mm (diameter) x 9mm● VU: 32.2mm × 21.1mm × 7.7mm
Flight Performance (can be effected by mechanical performance and payloads)	
Hovering Accuracy (GPS Mode)	<ul style="list-style-type: none">● Vertical: ± 0.8m● Horizontal: ± 2.5m
Max Yaw Angular Velocity	200° /s
Max Tilt Angle	45°
Max Ascent / Descent Speed	6m/s

FAQ

Abnormal LED Indication List

During the Checking Procedure, if abnormal LED Indicator occurs or even the system cannot work normally, please refer to the following list and aids troubleshooting.



- (1) "System initializing and self-checking LED flashes" are not correct ( Red LED appears in the last four green flashes). The autopilot system works abnormally. Please contact your dealer.
- (2) LED blinks Yellow 4 times quickly (). The system is warming up. You cannot start the motors until the 4 rapid yellow flashes disappear. If the warm up waiting is longer than 2 minutes, please power off for 5 minutes, cold start, and then connect the assistant software, enter the "Tools" -> IMU calibration, carry out the Advanced calibration.
- (3) After the system start and self-checking has finished, if the LED blinks Red, Green and Yellow () continually. Sensor error is too big. Please connect the assistant software, enter the "Tools" -> IMU calibration, carry out calibration.
- (4) At the first motors start, the system will check the sensors Bias and you are asked to keep the aircraft stationary (no need of horizontal level). If you cannot start the motors and the LED blinks Green 6 times quickly (), it means that the sensor error is too big. Please connect the assistant software, enter the "Tools" -> IMU calibration, carry out basic calibration.

Note: after the first successful motors start, this checking will be disabled and it is no need any more to keep the aircraft stationary during starting motors.
- (5) The system blinks Red LED quickly during flying. Low-voltage protection is triggered. Please land the aircraft ASAP.
- (6) The system blinks Yellow LED quickly during flying. FailSafe Mode is triggered. Pay attention that there is no tall buildings and trees to block your aircraft during go-home.
- (7) The LED blinks Red and Yellow alternately (). Compass error is too big.
 - a) There may be a ferromagnetic substance close to the Phantom. Lift the aircraft up about 1m from the ground, if there is no Red and Yellow flashing, then it will not affect the flight.
 - b) Otherwise, re-calibrate the compass.
 - c) If re-calibration does not work, please connect to the Assistant Software, select the "Tools" and follow the tips to carry out the required operation.

Fix the TBE (Toilet Bowl Effect) Problem

When flying in GPS ATTI. Mode and the compass calibration has been done correctly, should you find the aircraft rotating (Toilet bowl effect), or drifting when hovering. Please check the GPS module mounting orientation and then re-do the compass calibration. Carry out the following procedure to re-mount the GPS module.

In the following diagram (view from the top), the aircraft can appear to be rotating in both clockwise and counter-clockwise direction, please re-mount the GPS module correspondingly.

 is the rotating direction of aircraft,
  is the nose direction of aircraft,
  is the arrow direction on the GPS module, θ is the offset angle for GPS re-mounting (about 10-30°)

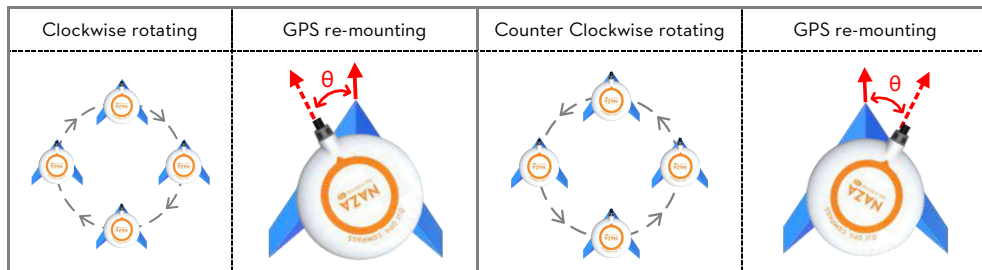

Should you find the multi-rotor does not track straight in forward flight.

Please carry out several more courses, the system will fix it automatically.

Motors Start failure caused by TX stick(s) mid-point error too big

If the TX stick(s) mid-point error is too big, Motors Start will fail when you execute the Combination Stick Commands (CSC) and lead to the aircraft will not takeoff.. And the LED will blink Red four times per second continually to warn you.

TX stick(s) mid-point error too big can be caused by the following reasons:

- (1) There is TX stick (except the throttle stick) not at center when power on the autopilot system.
- (2) The TX sticks has been trimmed, which leads to the large deviation of mid-point. For example, the SUB-TRIM has been adjusted for Futaba transmitter.
- (3) The TX stick(s) travel has larger asymmetry.

For the reason (1), please put all TX sticks at the mid-point, and then power cycle the autopilot system to re-record the mid-point. If the problem continues, that can be caused by the reason (2) or reason (3), you need to adjust the output range of your TX, and then use the Assistant Software to redo the TX calibration. Please carry out the following procedures.

- (1) Connect to the Assistant software, click Basic-> R/C-> Command Sticks Calibration, and push all TX sticks throughout their complete travel range to see if any stick cannot reach its largest position.
- (2) Adjust the largest travel of TX stick until the cursor on the Assistant software can reach both end positions, according to your TX manual.
- (3) Power cycle the autopilot system, note that power cycle is required.
- (4) Redo the TX calibration according to the Assistant software.

Attitude Controllable When One Motor Output is Failed

For Hexa-rotor, including Hexa-rotor I, Hexa-rotor V, Hexa-rotor IV and Hexa-rotor Y, aircraft is attitude controllable when one motor output is failed.

The NAZA-M can still control the attitude of the Hexa-rotor for a safe landing when one motor output of the Hexa-rotor has failed, for example, one motor is stopped or one propeller is broken, etc.

The control mode of NAZA-M should be in Atti. Mode or GPS Atti. Mode. The aircraft will rotate, due to an imbalance of torque; however, it can still be controlled by the Transmitter.

Select Course lock or home lock mode for flying the aircraft into a safe area to land when the aircraft is far away or the attitude can't be recognized. Even when the multi rotor is rotating, using Course lock or home lock mode will allow you to move the multi rotor in the corresponding Transmitter stick direction.

When used with other DJI products

The NAZA-M system communicates with other DJI products (e.g. H3-2D gimbal, BTU module, iOSD mini and iOSD Mark II) via the CAN-Bus port (CAN) of the NAZA PMU V2. You can plug new DJI products into any spare CAN-Bus port, since CAN-Bus ports on NAZA-M, CAN HUB, GCU, iOSD mini, iOSD Mark II and 2.4G Bluetooth Datalink are the same for the communications.

When there are not enough CAN-Bus ports for additional DJI products, then a DJI CAN HUB module is recommended. The following diagram is for your connection reference.

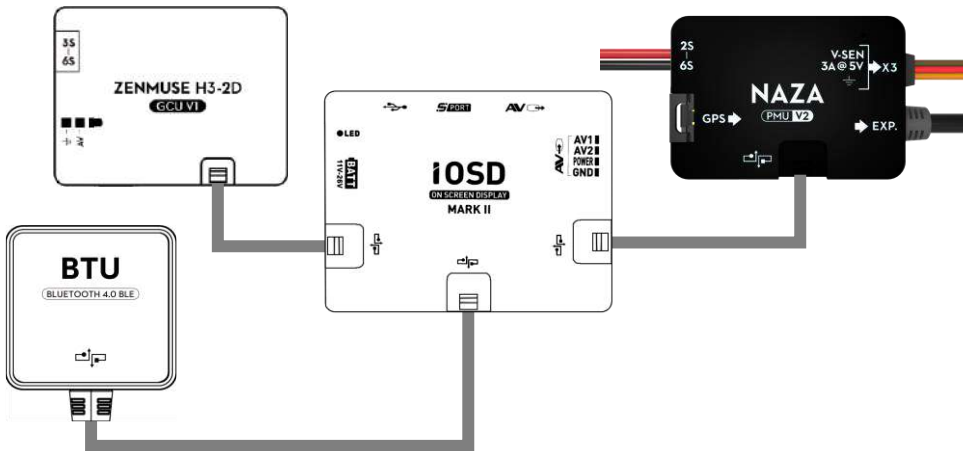

Fig.1 Used with iOSD Mark II

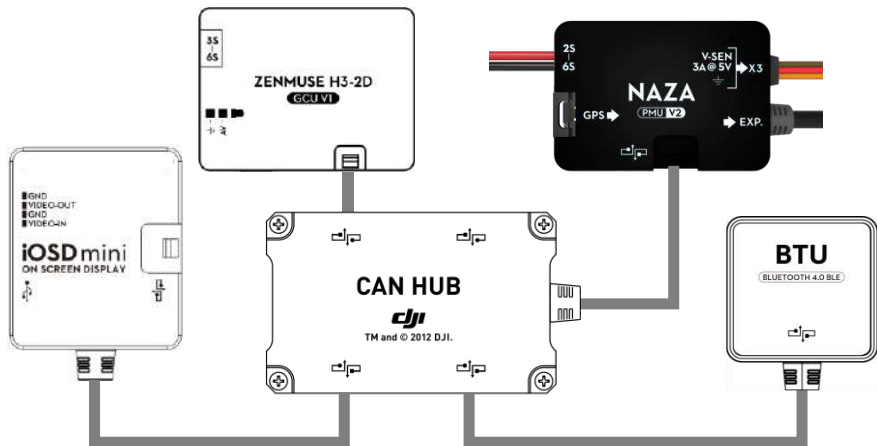

Fig.2 Used with CAN HUB

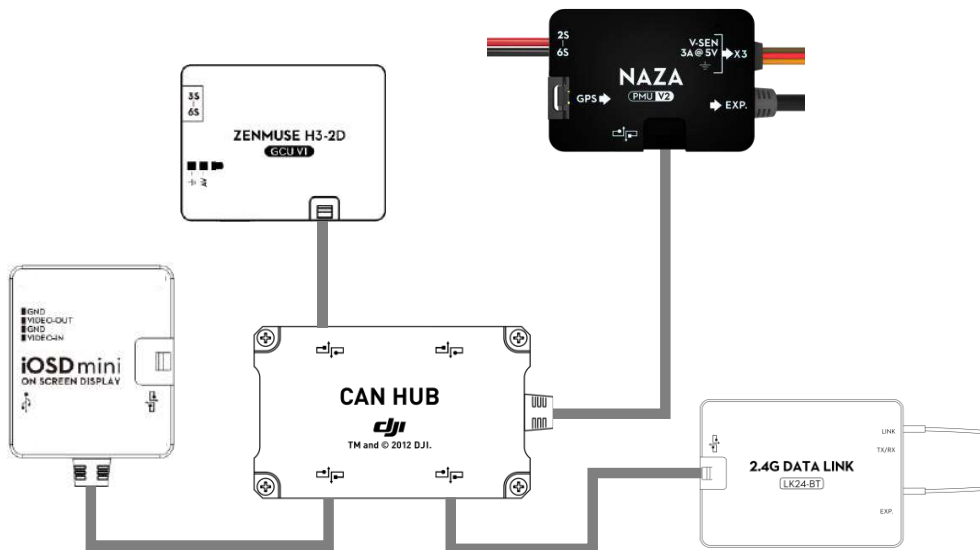

Fig.3 Use a CAN HUB to connect the 2.4G Bluetooth Datalink



Users can use the NM Assistant on the mobile device when a BTU module is connecting with the Ground end of the 2.4G Bluetooth Datalink (No need to connect another BTU module to the Flight control system).