

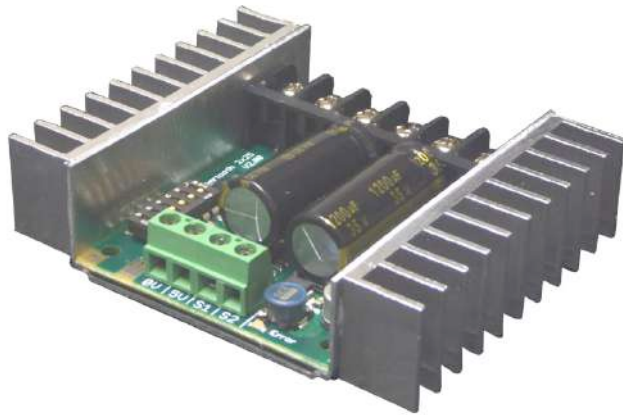

# DimensionEngineering

## Sabertooth 2x25 V2 User's Guide

March 2011



**Input voltage:** 6-30V nominal, 33.6V absolute max.

**Output Current:** Up to 25A continuous per channel. Peak loads may be up to 50A per channel for a few seconds.

**5V Switching BEC:** Up to 1A continuous and 1.5A peaks across the entire range of input voltages.

**Recommended power sources are:**

- 5 to 20 cells high capacity NiMH or NiCd
- 2s to 8s lithium ion or lithium polymer. Sabertooth motor drivers have a lithium battery mode to prevent cell damage due to over-discharge of lithium battery packs.
- 6v to 30V high capacity lead acid
- 6v to 30V power supply (when in parallel with a suitable battery).

**All batteries must be capable of maintaining a steady voltage when supplying 20+ amps** (AA or 9V batteries aren't going to cut it! An 18Ah lead-acid battery is a good starting point)

**Dimensions:**

Size: 2.6" x 3.2" x .82"	65 x 80 x 21mm
Weight: 3.2oz / 90g	

# Features

---

## **Mixed and independent options:**

Sabertooth features mixed modes designed especially for differential drive robots, where two motors provide both steering and propulsion. It also has independent options in all operating modes. This is useful for if you have two motors to control, but they aren't necessarily being used to drive a differential drive robot. The motors do not need to be matched or even similar, as long as they both are within Sabertooth's operating limits.

## **Synchronous regenerative drive:**

Going one step farther than just regenerative braking, a Sabertooth motor driver will return power to the battery any time a deceleration or motor reversal is commanded. This can lead to dramatic improvements in run time for systems that stop or reverse often, like a placement robot or a vehicle driving on hilly terrain. This drive scheme also saves power by returning the inductive energy stored in the motor windings to the battery each switching cycle, instead of burning it as heat in the motor windings. This makes part-throttle operation very efficient.

## **Ultra-sonic switching frequency:**

Sabertooth 2x25 features a PWM frequency of 32kHz, which is well above the maximum frequency of human hearing. Unlike some other motor drivers, there is no annoying whine when the motor is on, even at low power levels.

## **Thermal and overcurrent protection:**

Sabertooth features dual temperature sensors and overcurrent sensing. It will protect itself from failure due to overheating, overloading and short circuits.

## **Easy mounting and setup:**

Sabertooth has screw terminals for all inputs and outputs. There are four mounting holes, which accept 4-40 screws. Mounting hardware is included. All operating modes and options are set with DIP switches – there are no jumpers to struggle with or lose. No soldering is required.

## **Compact Size:**

Sabertooth utilizes surface mount construction to provide the most power from a compact package. Its small size and light weight mean you have more space for cargo, batteries, or can make your robot smaller and more nimble than the competition.

## **Carefree reversing:**

Unlike some other motor drivers, there is no need for the Sabertooth to stop before being commanded to reverse. You can go from full forward immediately to full reverse or vice versa. Braking and acceleration are proportional to the amount of reversal commanded, so gentle or rapid reversing is possible.

## **Many operating modes:**

With analog, R/C and serial input modes, as well as dozens of operating options, the Sabertooth has the flexibility to be used over and over, even as your projects grow more sophisticated. Yet it is simple enough to use for your first robot project.

# Hooking up the Sabertooth motor driver

---

All connections to the Sabertooth are done with screw terminals. This makes it easy to set up and reconfigure your project. If you've never used screw terminal connections before, here is a quick overview.

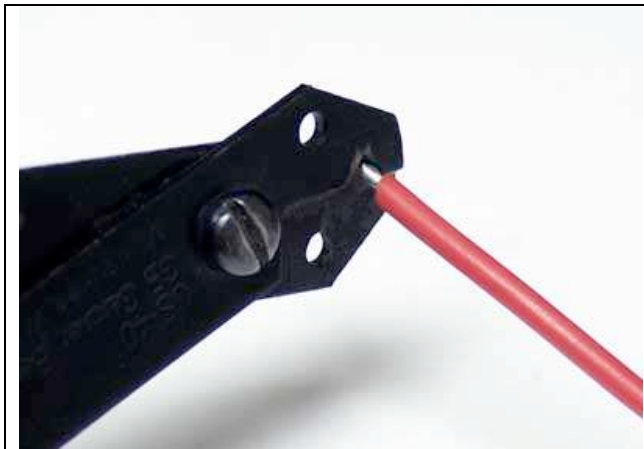

**Step 1:** Strip the wire which you are using approximately  $\frac{1}{4}$ " The wires may be 12 gauge to 30 gauge. Use thicker wire for high current applications.

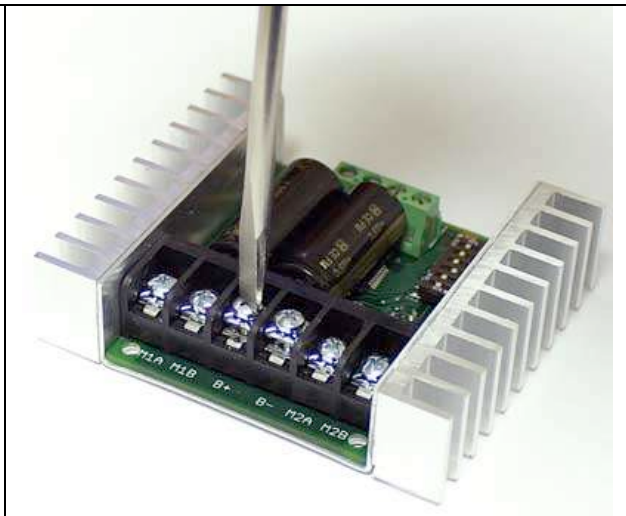

**Step 2:** With a large screwdriver, turn the top screw counter-clockwise until it stops gently.

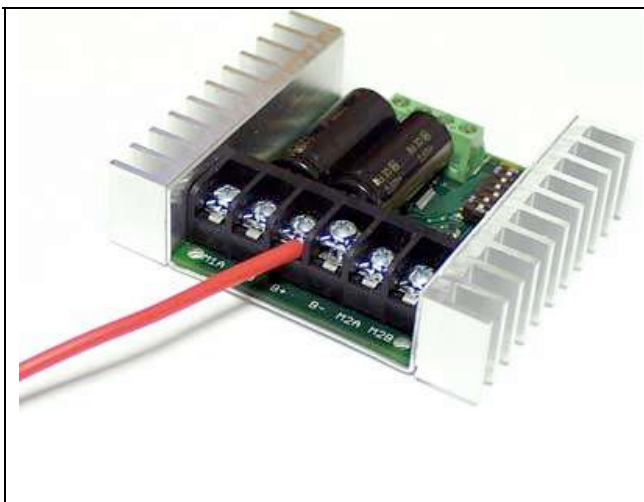

**Step 3:** Insert the stripped portion of the wire into the opening in the screw terminal

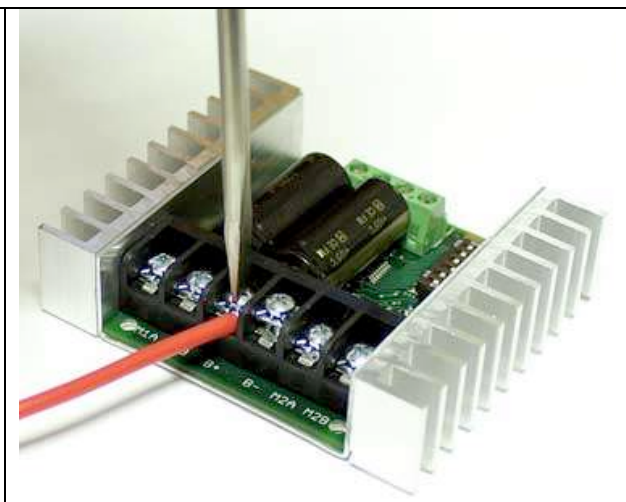

**Step 4:** Turn the top screw clockwise until you encounter resistance, then tighten the screw firmly. Pull on the wire gently to ensure that it is secured.

## Battery Terminals B+ and B-

---

The battery or power supply is connected to terminals B- and B+. B- connects to the negative side of the battery (usually black.) B+ connects to the positive side of the battery (usually red or yellow.) It is usually best to connect the battery through a connector instead of directly to the motor driver. This makes it easy to unplug the battery for charging, and prevents plugging in the battery backwards.

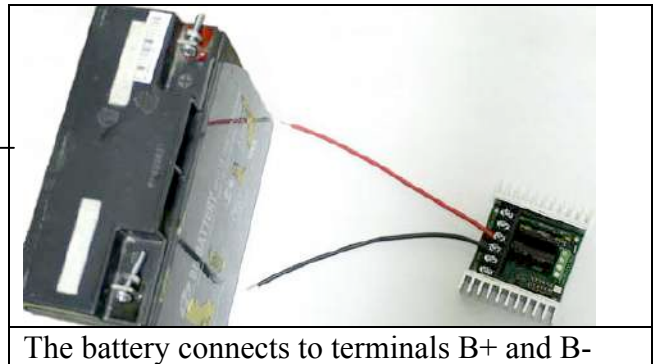

The battery connects to terminals B+ and B-

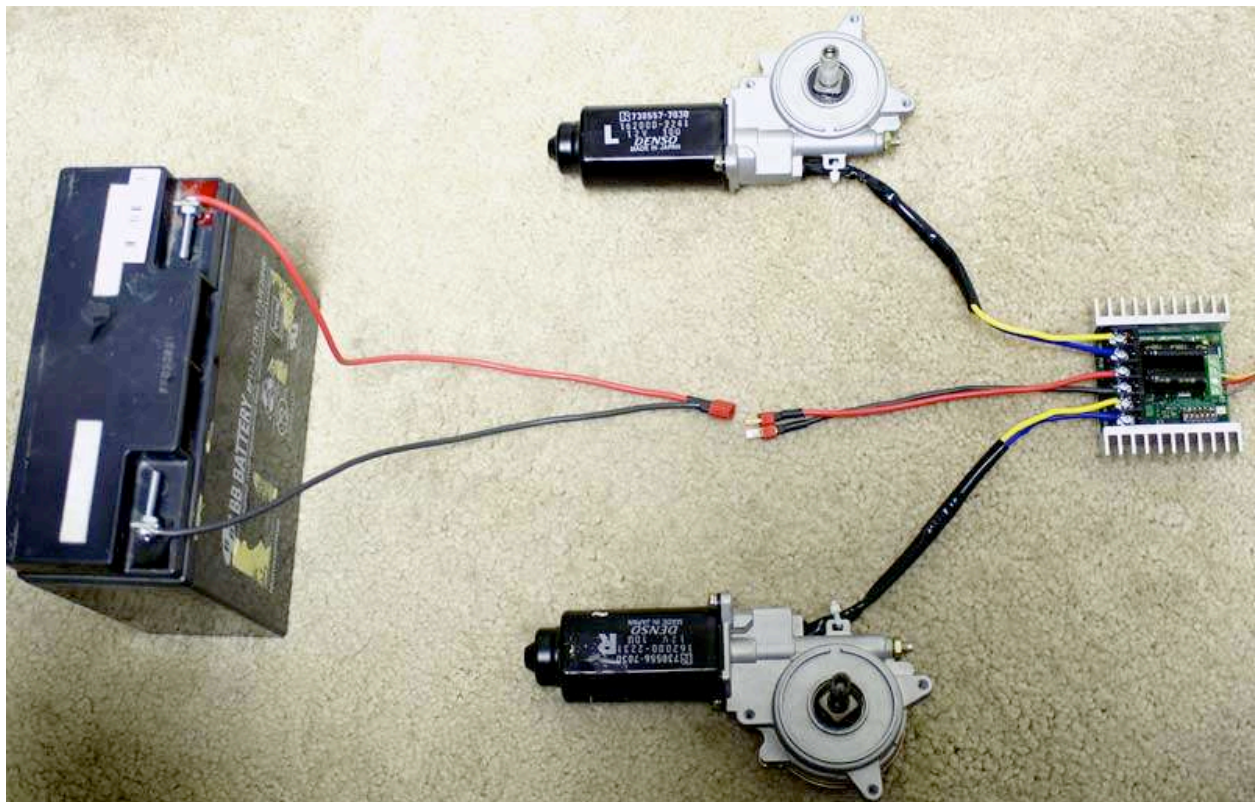

Using a battery connector to connect/disconnect power to Sabertooth

**Warning! Be very careful to wire and plug in the battery and connector correctly. Connecting the battery backwards will destroy the Sabertooth and will void the warranty.**



## Motor Terminals

---

Motor 1 is connected to terminals M1A and M1B as shown below. If the motor runs in the opposite way that you want, you may reverse the motor wires to reverse rotation.

Motor 2 is connected to terminals M2A and M2B

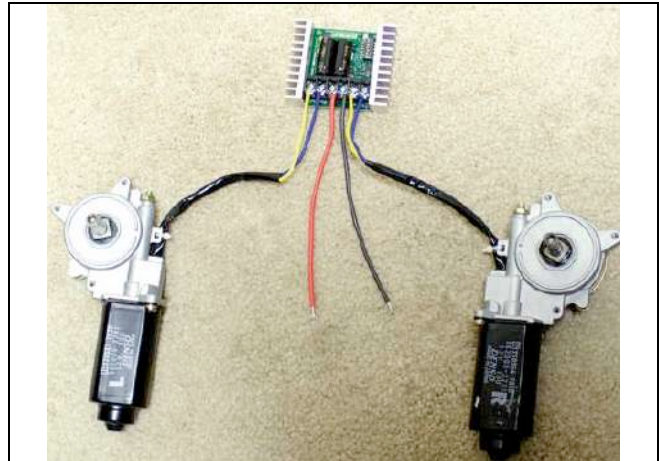

The motors connect to terminals M1A/B and M2A/B

## Signal Input Terminals S1 and S2

---

The input signals that control the Sabertooth are connected to terminals S1 and S2. If you are running in analog mode, it is important to have both the signal connected before applying power to the device. Otherwise, the motors may start unexpectedly.

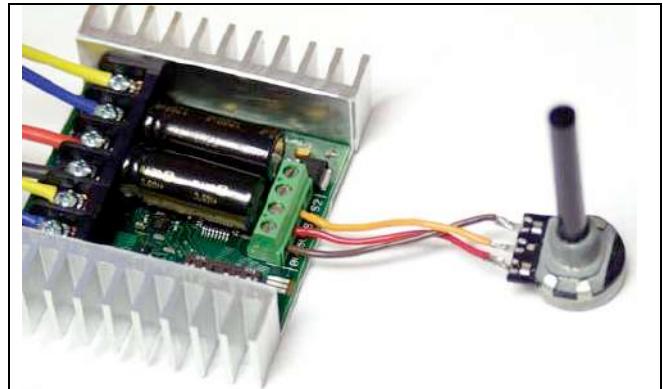

The input signals connect to terminal S1 and/or S2

## Power terminals 0V and 5V

The 0V and 5V connections are used to power and interface to low-power control circuits.

The 5V connection is a 5v power **output**. The 2x25 utilizes a **1 Amp switching BEC** to power the onboard electronics as well as to provide power to your receiver and up to 4 standard analog servos. You can power

anything that requires 5V straight from the Sabertooth 2x25. There is no need for an external BEC unless you need more than 1 Amp. The BEC will work at full rated output throughout the Sabertooth's operating voltage range. You can use the BEC at full capacity whether you are running 7V or 24V in.

The 0V connection is the signal ground for the Sabertooth. In order to receive input signals correctly, it must be connected to the ground of the device sending the signals.

Using the 0V and 5v connections to power a radio receiver in R/C mode and potentiometer in analog mode is shown in Figures 2.1 and 2.2. If you are using multiple Sabertooths running from the same radio receiver, only one should have the 5v line connected.

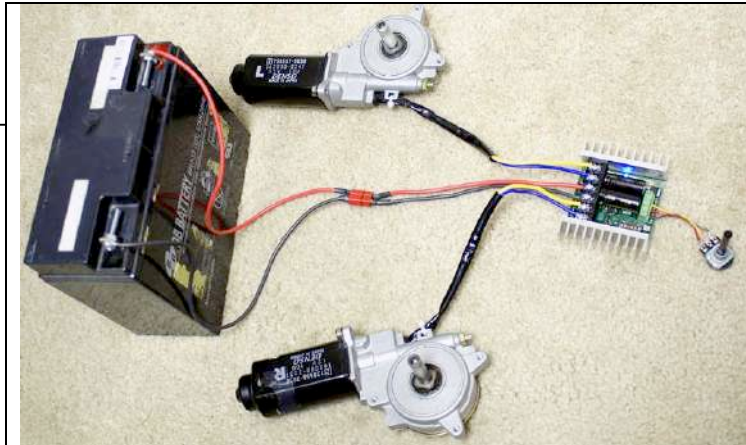

The 5V terminal can be used to power small loads, like a potentiometer or a radio receiver. The 0V signal must be connected to the ground of the device generating the input signal.

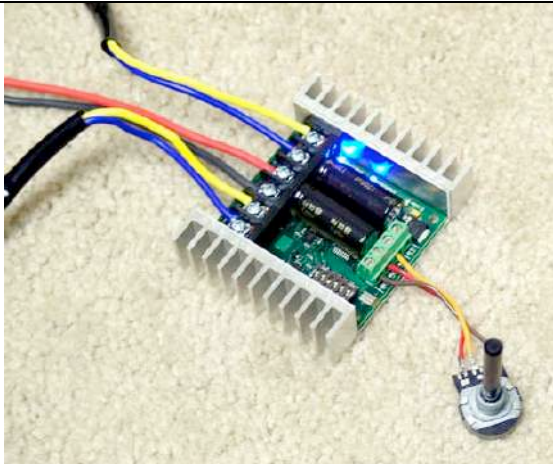

Figure 2.1: Analog input using a potentiometer powered from terminal 5V

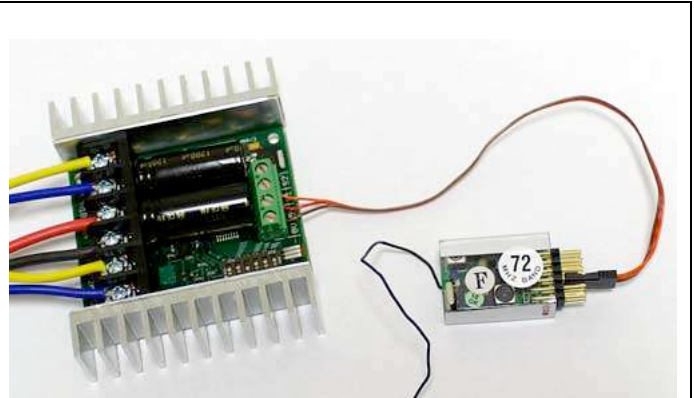

Figure 2.2: R/C input using a receiver powered from terminal 5V

## Status and Error LEDs

Sabertooth 2x25 has three indicator LEDs.

The blue LED marked Status1 is used to communicate various information about the current state. In most cases Status1 acts as a power indicator. In R/C mode, it glows dimly if there is no RC link present and brightly if there is an RC link.

The blue LED marked Status2 is only used in lithium mode. It blinks to indicate the number of lithium cells detected.

The red Error LED illuminates if the Sabertooth has detected a problem. It will light if the driver has shut down due to a depleted battery or due to overheating, overcurrent or overvoltage. If you are using a NiCd or NiMH battery, and commanding an acceleration causes the motor to jerk and the Error LED to flash on and off, the battery is depleted.



## Mounting your Sabertooth 2x25

The Sabertooth is supplied with four mounting holes. These can be used to attach it to your robot. The centers of the mounting holes form a 1.75" x 2.25" rectangle. The holes are .125 inches in diameter. The proper size screw is a 4-40 round head machine or wood screw. Four 5/8" long machine screws and nuts are included.

If your robot or device is constructed from insulating materials such as wood or plastic, it may be necessary to mount the Sabertooth on standoffs to allow air to circulate. An example is shown in Figure 2.3

If your robot or device is constructed from metal, it is usually better to attach the bottom heat spreader of the Sabertooth directly to the frame, without standoffs. This will allow your frame to act as a heat sink and will cause the Sabertooth to run cooler. This is shown in Figure 2.4

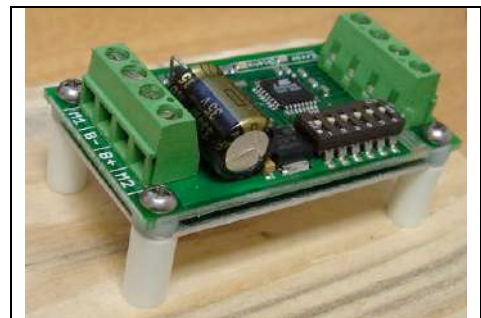

Figure 2.3: Mounted to a wood frame using standoffs



Figure 2.4: Mounted directly to a metal frame

# Operating Modes Overview

---

## **Mode 1: Analog Input**

Analog input mode takes one or two analog inputs and uses those to set the speed and direction of the motor. The valid input range is 0v to 5v. This makes the Sabertooth easy control using a potentiometer, the PWM output of a microcontroller (with an RC filter) or an analog circuit. Major uses include joystick or foot-pedal controlled vehicles, speed and direction control for pumps and machines, and analog feedback loops.

## **Mode 2: R/C Input**

R/C input mode takes two standard R/C channels and uses those to set the speed and direction of the motor. There is an optional timeout setting. When timeout is enabled, the motor driver will shut down on loss of signal. This is for safety and to prevent the robot from running away should it encounter interference and should be used if a radio is being used to control the driver. If timeout is disabled, the motor driver will continue to drive at the commanded speed until another command is given. This makes the Sabertooth easy to interface to a Basic Stamp or other low-speed microcontrollers.

## **Mode 3: Simplified serial.**

Simplified serial mode uses TTL level RS-232 serial data to set the speed and direction of the motor. This is used to interface the Sabertooth to a PC or microcontroller. If using a PC, a level converter such as a MAX232 chip must be used. The baud rate is set via DIP switches. Commands are single-byte. There is also a Slave Select mode which allows the use of multiple Sabertooth 2x25 from a single microcontroller serial port.

## **Mode 4: Packetized serial**

Packetized serial mode uses TTL level RS-232 serial data to set the speed and direction of the motor. There is a short packet format consisting of an address byte, a command byte, a data byte and a 7 bit checksum. Packetized serial automatically detects the transmitted baud rate based on the first character sent, which must be 170. Address bytes are set via dip switches. Up to 8 Sabertooth motor drivers may be ganged together on a single serial line. This makes packetized serial the preferred method to interface multiple Sabertooths to a PC or laptop. Because Sabertooth uses the same protocol as our SyRen single motor drivers, both can use used together from the same serial master.



## Lithium cutoff:

Switch 3 of the DIP switch block selects lithium cutoff. If switch 3 is in the down position as shown the Sabertooth will automatically detect the number of series lithium cells at startup, and set a cutoff voltage of 3.0 volts per cell. The number of detected cells is flashed out on the Status LED. If the number of cells detected is too low, your battery is in a severely discharged state and must be charged before operation. Failure to do so may cause damage to the battery pack. When 3.0V per cell is reached, the Sabertooth will shut down, preventing damage to the battery pack. This is necessary because a lithium battery pack discharged below 3.0v per cell will lose capacity and batteries discharged below 2.0v per cell may not ever recharge. Lithium cutoff mode may also be useful to increase the number of battery cycles you can get when running from a lead acid battery in non-critical applications. Because the system will continue to draw some power, even with the motor shut down, it is important to unplug the battery from the Sabertooth promptly once the cutoff is reached when using lithium batteries. If the Sabertooth is being run from NiCd, NiMH or alkaline batteries, or from a power supply, switch 3 should be in the up position.

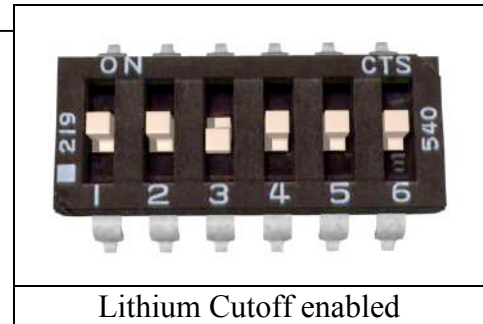

# Mode 1: Analog Input

---

Analog input mode is selected by setting switches 1 and 2 to the UP position. Switch 3 should be either up or down, depending on the battery type being used. Inputs S1 and S2 are configured as analog inputs. The output impedance of the signals fed into the inputs should be less than 10k ohms for best results. If you are using a potentiometer to generate the input signals, a 1k, 5k or 10k linear taper pot is recommended. In all cases, an analog voltage of 2.5V corresponds to no movement. Signals above 2.5V will command a forward motion and signals below 2.5V will command a backwards motion.

There are three operating options for analog input. These are selected with switches 4, 5 and 6. All the options can be used independently or in any combination.

## Switch 4: Mixing Mode

---

If switch 4 is in the UP position, the Sabertooth 2x25 is in **Mixed** mode. This mode is designed for easy steering of differential-drive vehicles. The analog signal fed into S1 controls the forward/back motion of the vehicle, and the analog signal fed into S2 controls the turning motion of the vehicle. If Switch 4 is in the DOWN position, the Sabertooth 2x25 is in Independent mode. In Independent mode, the signal fed to S1 directly controls Motor 1 (outputs M1A and M1B) and the signal fed to S2 controls Motor 2.

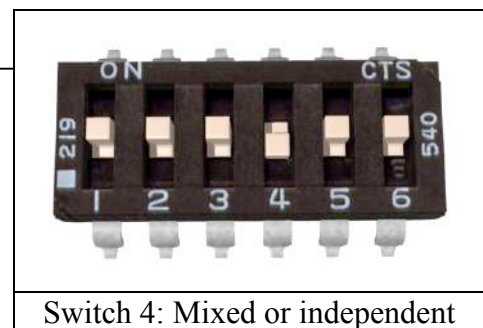

Switch 4: Mixed or independent

## Switch 5: Exponential response

---

If switch 5 is in the DOWN position, the response to input signals will be exponential. This softens control around the zero speed point, which is useful for control of vehicles with fast top speeds or fast max turning rates. If switch 5 is in the UP position, the response is linear.

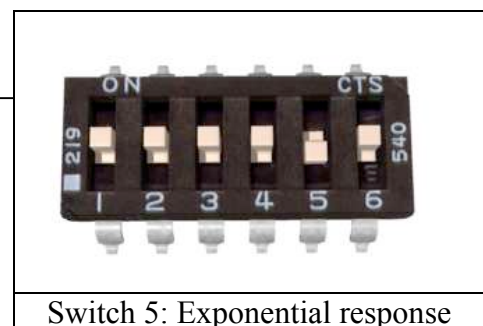

Switch 5: Exponential response

Utilizing the DEScribe software, this mode will allow you to create and implement a custom throttle response curve. There are options to use Cubic, Linear, and Constant curves. Each of these types are editable in the software. You will find more information later in this guide.

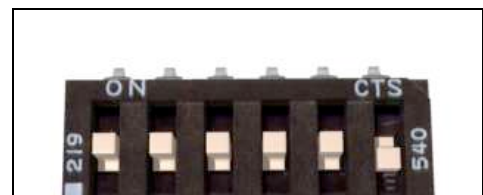

## Switch 6: 4x sensitivity

---

If switch 6 is in the UP position, the input signal range is from 0v to 5v, with a zero point of 2.5v.

If switch 6 is in the DOWN position, 4x sensitivity mode is enabled. In this mode, the input signal range is from 1.875V to 3.125V, with a zero point of 2.5v. This is useful for building analog feedback loops

## Note on using filtered PWM in Analog Mode

---

If you are using a filtered PWM signal from a microcontroller to generate the analog voltage, an R/C filter with component values 10k ohms and at least .1uf is recommended as shown in **Figure 4.1**. Using a larger value filter capacitor such as 1uf or 10uf will result in smoother motor operation, at a cost of slower transient response. A PWM frequency higher than 1000Hz is recommended.

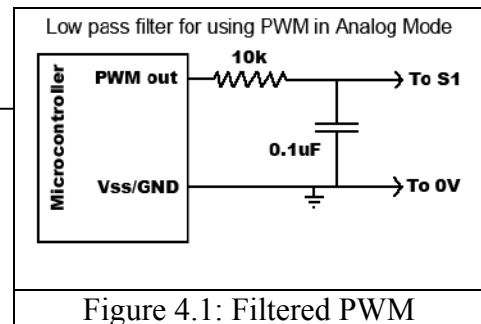

## Custom Analog Voltage Range – DEScribe software

---

Utilizing the DEScribe software, it is now possible to define your own voltage ranges for the analog input option. After opening the DEScribe software, click on the analog tab. You will see the screen shown below:

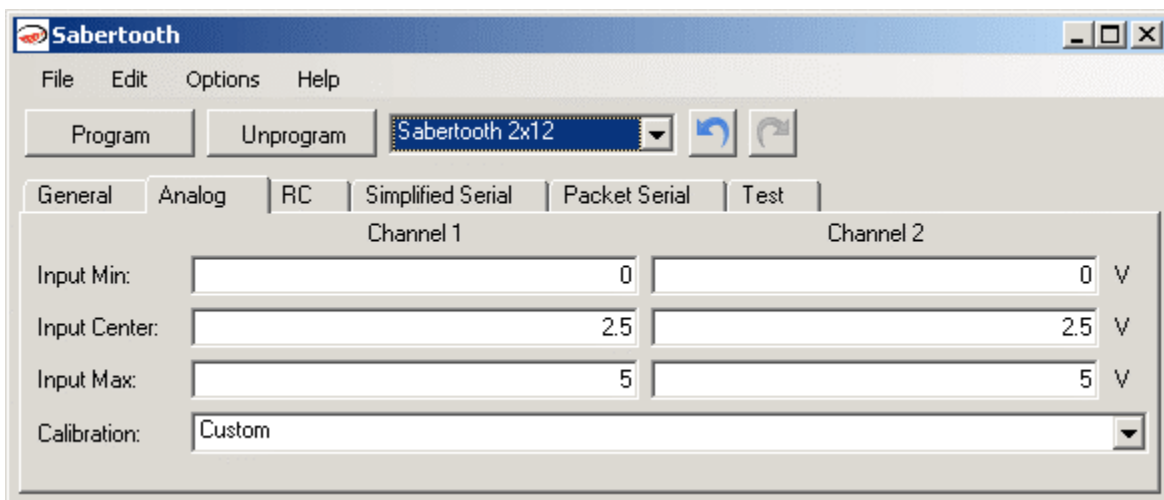

Once you have your ranges set, all you have to do is connect your Sabertooth 2x25 to the USB adapter and press Program!

## Mode 2: R/C Input

---

R/C input mode is used with a standard hobby Radio control transmitter and receiver, or a microcontroller using the same protocol. R/C mode is selected by setting switch 1 to the DOWN position and switch 2 to the UP position. If running from a receiver, it is necessary to obtain one or more servo pigtails and hook them up according to figure 5.1. If there are only motor drivers being used it is acceptable to power the receiver or microcontroller directly from the Sabertooth as shown. If using a receiver pack, do not connect power to the 5V line of the Sabertooth because the maximum voltage it can tolerate is 6V.

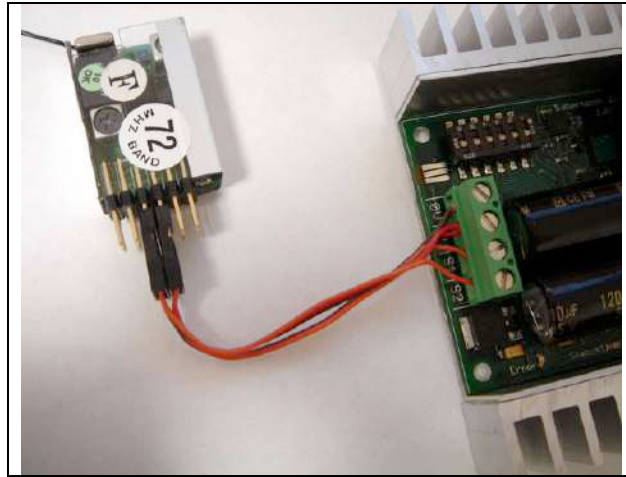

Figure 5.1: R/C connection

There are three operating options for R/C mode. These are selected with switches 4, 5 and 6.

### Switch 4: Mixing Mode

---

When Switch 4 is in the UP position, Mixed mode is selected. In this mode, the R/C signal fed to the S1 input controls the forward/backwards motion of the vehicle. This is usually connected to the throttle channel of a pistol grip transmitter, or the elevator channel of a dual stick transmitter. The R/C signal fed to the S2 input controls the turning of the vehicle.

When switch 4 is in the DOWN position, Independent mode is selected. In this mode, the signal fed to the S1 input directly controls Motor 1 (M1A and M1B) and the signal fed to S2 controls Motor 2.

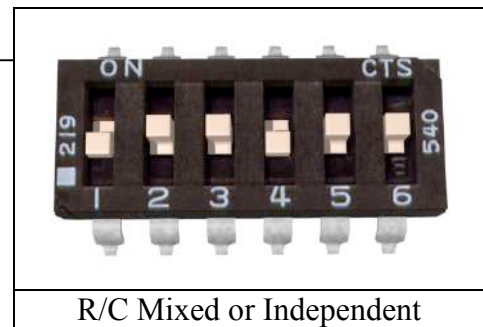



## Switch 5: Exponential response

If switch 5 is in the UP position, the response is linear.  
If switch 5 is in the DOWN position, the response to input signals will be exponential. This softens control around the zero speed point, which is useful for control of vehicles with fast top speeds or fast max turning rates.

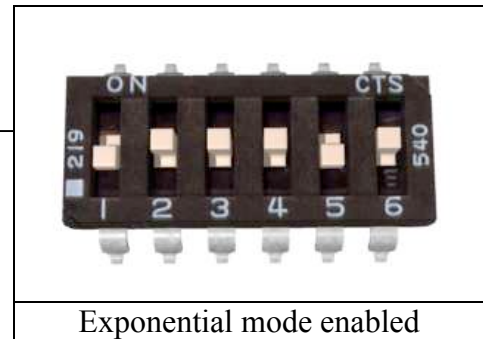

Utilizing the DEScribe software, this mode will allow you to create and implement a custom throttle response curve. There are options to use Cubic, Linear, and Constant curves. Each of these types are editable in the software.

## Switch 6: R/C Mode/Microcontroller mode select

If switch 6 is in the UP position, then the Sabertooth is in standard R/C mode. This mode is designed to be used with a hobby-style transmitter and receiver. It automatically calibrates the control center and endpoints to maximize stick usage. It also enables a Timeout Failsafe, which will shut down the motors if the Sabertooth stops receiving correct signals from the receiver.

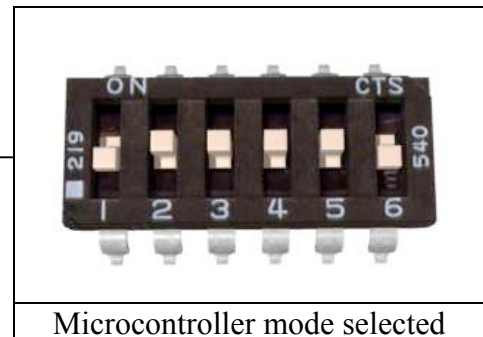

If switch 6 is set in the DOWN position, then Microcontroller mode is enabled. This disables the Timeout Failsafe and auto-calibration. This means that the Sabertooth will continue to drive the motor according to the last command until another command is given. If the control link is possible unreliable – like a radio - then this can be dangerous due to the robot not stopping. However, it is extremely convenient if you are controlling the Sabertooth from a microcontroller. In this case, commanding the controller can be done with as little as three lines of code.

Output\_High(Pin connected to S1)

Delay(1000us to 2000us)

Output\_Low(Pin connected to S1)

## A note on certain microprocessor receivers

Some receivers, such as the Spektrum AR6000, will output servo pulses before a valid transmitter signal is present. This will cause the Sabertooth to autocalibrate to the receiver's startup position which may not correspond to the center stick position, depending on trim settings. This may cause the motors to move slowly, even when the transmitter stick is centered. If you encounter this, either consult your receiver manual to reprogram the startup position, or adjust your transmitter trims until the motors stop moving.

If you are having issues, and the ranges for your transmitter/receiver are known, you can use the DEScribe software to tailor the ranges to your individual setup.

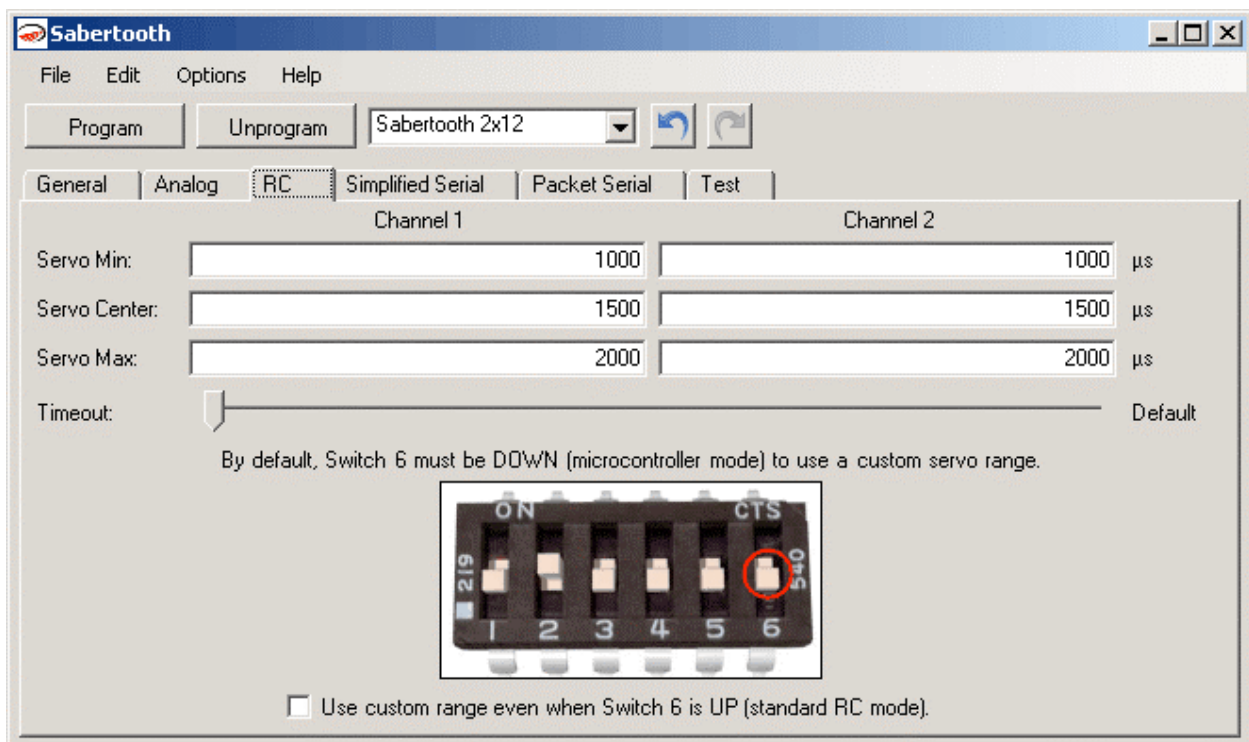

## Mode 3: Simplified Serial Mode

Simplified serial uses TTL level single-byte serial commands to set the motor speed and direction. This makes it easy to interface to microcontrollers and PCs, without having to implement a packet-based communications protocol. Simplified serial is a one-direction only interface. The transmit line from the host is connected to S1. The host's receive line is not connected to the Sabertooth. Because of this, multiple drivers can be connected to the same serial transmitter. If using a true RS-232 device like a PC's serial port, it is necessary to use a level converter to shift the -10V to 10V rs-232 levels to the 0v-5v TTL levels the Sabertooth is expecting. This is usually done with a Max232 type chip. If using a TTL serial device like a microcontroller, the TX line of the microcontroller may be connected directly to S1.

Because Sabertooth controls two motors with one 8 byte character, when operating in Simplified Serial mode, each motor has 7 bits of resolution. Sending a character between 1 and 127 will control motor 1. 1 is full reverse, 64 is stop and 127 is full forward. Sending a character between 128 and 255 will control motor 2. 128 is full reverse, 192 is stop and 255 is full forward. Character 0 (hex 0x00) is a special case. Sending this character will shut down both motors.

### Baud Rate Selection

Simplified Serial operates with an 8N1 protocol – 8 data bytes, no parity bits and one stop bit. The baud rate is selected by switches 4 and 5 from the following 4 options

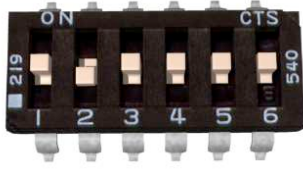
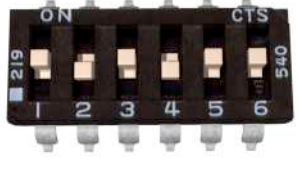
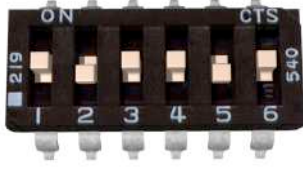
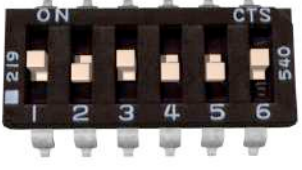
	
2400 Baud: 01x00x	9600 Baud: 01x10x
	
19200 Baud: 01x01x	38400 Baud: 01x11x

What baud rate to use is dependent on what your host can provide and the update speed necessary. 9600 baud or 19200 baud is recommended as the best starting points. If communication is unreliable, decrease the baud rate. If communications are reliable, you may increase the baud rate. The maximum update speed on the Sabertooth is approximately 2000 commands per second. Sending characters faster than this will not cause problems, but it will not increase the responsiveness of the controller either.

The baud rate may be changed with power on by changing the DIP switch settings. There is no need to reset or cycle power after a baud rate change.

There are 2 operating options for Simplified Serial. These are selected by the position of Switch 6.



## Option 1: Standard Simplified Serial Mode

Serial data is sent to input S1. The baud rate is selected with switches 4 and 5. Commands are sent as single bytes. Sending a value of 1-127 will command motor 1. Sending a value of 128-255 will command motor 2. Sending a value of 0 will shut down both motors.

## Option 2: Simplified Serial with Slave Select

This mode is used when it is desirable to have multiple Sabertooth motor drivers running from the same serial transmitter, but you do not wish to use packetized serial. A digital signal (0v or 5v) is fed to the S2 input. This is controlled by the host microcontroller. If the signal on S2 is logic high (5v) when the serial command is sent, then the driver will change to the new speed. If the signal on S2 is not high when the command is sent, then command will be ignored. Pseudo-code demonstrating this is shown below. After sending the signal, allow about 50 us before commanding the Slave Select line to a logic LOW to allow time for processing. A hookup diagram and example pseudo-code are shown in **Figures 6.2** and **6.3**.

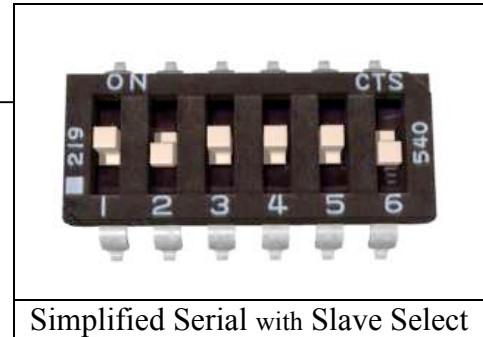

Simplified Serial with Slave Select

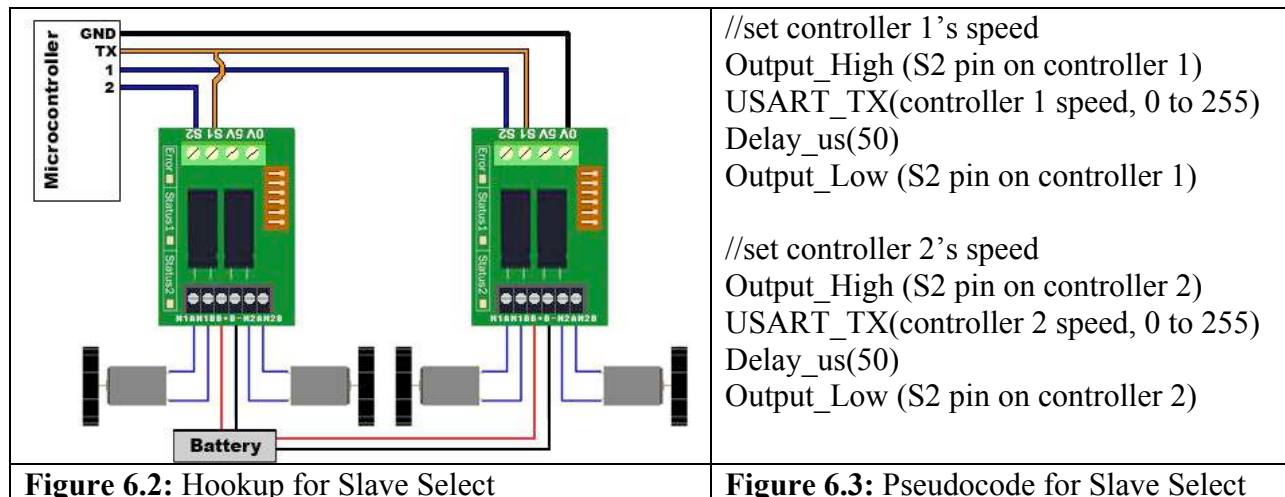



## Mode 4: Packetized Serial Mode

---

Packetized Serial uses TTL level multi-byte serial commands to set the motor speed and direction. Packetized serial is a one-direction only interface. The transmit line from the host is connected to S1. The host's receive line is not connected to the Sabertooth. Because of this, multiple Sabertooth 2x25 motor drivers can be connected to the same serial transmitter. It is also possible to use SyRen and Sabertooth motor drivers together from the same serial source, as well as any other serial device, as long as it will not act on the packets sent to the Sabertooth. If using a true RS-232 device like a PC's serial port, it is necessary to use a level converter to shift the -10V to 10V rs-232 levels to the 0v-5v TTL. Packetized serial uses an address byte to select the target device. The baud rate is selected automatically by sending the bauding character (170 in decimal, AA in hex) before any commands are sent.

### Packet Overview

---

The packet format for the Sabertooth consists of an address byte, a command byte, a data byte and a seven bit checksum. Address bytes have value greater than 128, and all subsequent bytes have values 127 or lower. This allows multiple types of devices to share the same serial line.

An example packet and pseudo-code to generate it are shown in **Figures 7.1** and **7.2**

<p><u>Packet</u> Address: 130 Command : 0 Data: 64 Checksum: 66</p>	<pre>Void DriveForward(char address, char speed) {   Putc(address);   Putc(0);   Putc(speed);   Putc((address + 0 + speed) &amp; 0b01111111); }</pre>
Figure 7.1: Example 50% forward	Figure 7.2: Pseudocode to generate 7.1

### Baud Rate Selection:

---

Packetized Serial operates with an 8N1 protocol – 8 data bytes, no parity bits and one stop bit. The baud rate is set at **9600 baud** from the factory. This value can be changed by sending the proper baud rate selection packet once the unit has powered on. Changed baud rates will be active after a power cycle. Once you set it, it stays that way until you change the rate again. See the 'Setting Commands' page for further details on how to change the baud rate. Baud rate can also be changed using the DEScribe software.

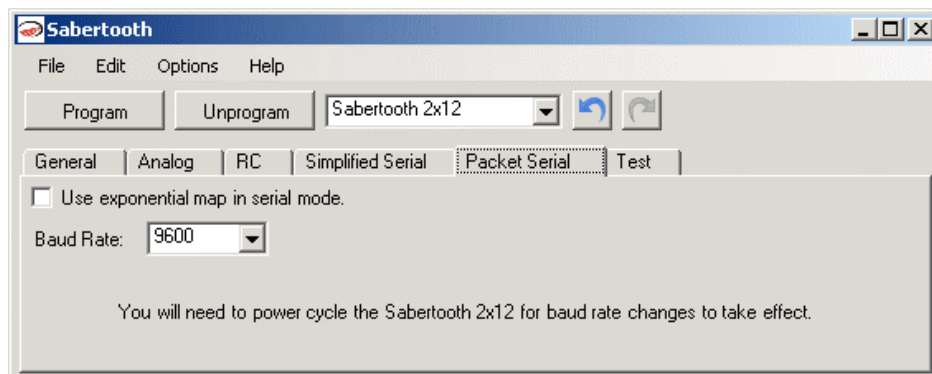

Changing baud rate in the DEScribe software

# Address Byte Configuration:

Address bytes are set by switches 4, 5 and 6. Addresses start at 128 and go to 135. The switch settings for the addresses are shown in the chart below

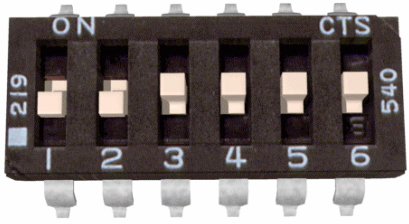
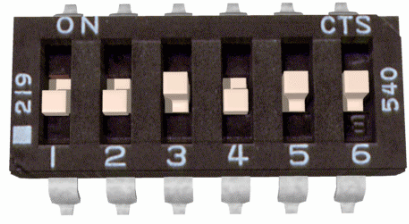
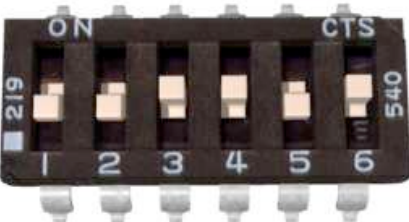
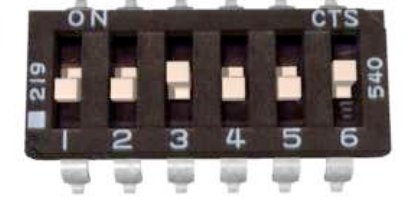
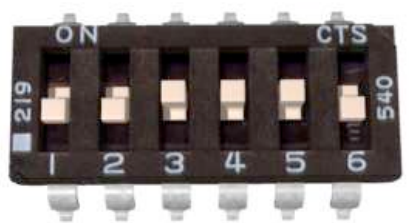
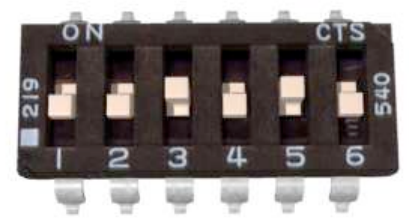
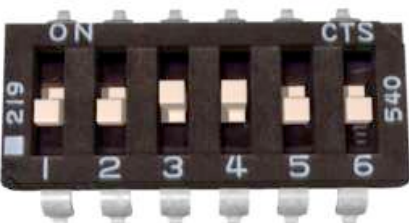
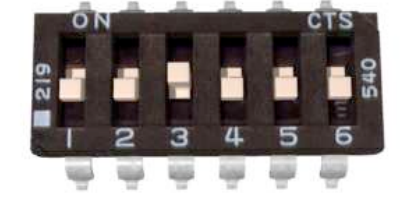
 <p>A 6-pin DIP switch assembly with pins labeled 1 through 6. Switches 4, 5, and 6 are in the 'ON' position. Labels 'ON' and 'CTS' are at the top, and '219' and '540' are on the sides.</p>	 <p>A 6-pin DIP switch assembly with pins labeled 1 through 6. Switches 4, 5, and 6 are in the 'ON' position. Labels 'ON' and 'CTS' are at the top, and '219' and '540' are on the sides.</p>
Address: 128	Address: 129
 <p>A 6-pin DIP switch assembly with pins labeled 1 through 6. Switches 4, 5, and 6 are in the 'ON' position. Labels 'ON' and 'CTS' are at the top, and '219' and '540' are on the sides.</p>	 <p>A 6-pin DIP switch assembly with pins labeled 1 through 6. Switches 4, 5, and 6 are in the 'ON' position. Labels 'ON' and 'CTS' are at the top, and '219' and '540' are on the sides.</p>
Address: 130	Address: 131
 <p>A 6-pin DIP switch assembly with pins labeled 1 through 6. Switches 4, 5, and 6 are in the 'ON' position. Labels 'ON' and 'CTS' are at the top, and '219' and '540' are on the sides.</p>	 <p>A 6-pin DIP switch assembly with pins labeled 1 through 6. Switches 4, 5, and 6 are in the 'ON' position. Labels 'ON' and 'CTS' are at the top, and '219' and '540' are on the sides.</p>
Address: 132	Address: 133
 <p>A 6-pin DIP switch assembly with pins labeled 1 through 6. Switches 4, 5, and 6 are in the 'ON' position. Labels 'ON' and 'CTS' are at the top, and '219' and '540' are on the sides.</p>	 <p>A 6-pin DIP switch assembly with pins labeled 1 through 6. Switches 4, 5, and 6 are in the 'ON' position. Labels 'ON' and 'CTS' are at the top, and '219' and '540' are on the sides.</p>
Address: 134	Address: 135

## Commands:

---

The command byte is the second byte of the packet. There are four possible commands in packetized serial mode. Each is followed by one byte of data

### **0: Drive forward motor 1 (decimal 0, binary 0b00000000, hex 0h00)**

This is used to command motor 1 to drive forward. Valid data is 0-127 for off to full forward drive. If a command of 0 is given, the Sabertooth will go into power save mode for motor 1 after approximately 4 seconds.

### **1: Drive backwards motor 1 (decimal 1, binary 0b00000001, hex 0h01)**

This is used to command motor 1 to drive backwards. Valid data is 0-127 for off to full reverse drive. If a command of 0 is given, Sabertooth will go into power save mode for motor 1 after approximately 4 seconds.

### **2: Min voltage (decimal 2, binary 0b00000010, hex 0h02)**

This is used to set a custom minimum voltage for the battery feeding the Sabertooth. If the battery voltage drops below this value, the output will shut down. This value is cleared at startup, so much be set each run. The value is sent in .2 volt increments with a command of zero corresponding to 6v, which is the minimum. Valid data is from 0 to 120. The function for converting volts to command data is

$$\text{Value} = (\text{desired volts}-6) \times 5$$

### **3: Max voltage (decimal 3, binary 0b00000011, hex 0h03)**

This is used to set a custom maximum voltage. If you are using a power supply that cannot sink current such as an ATX supply, the input voltage will rise when the driver is regenerating (slowing down the motor) Many ATX type supplies will shut down if the output voltage on the 12v supply rises beyond 16v. If the driver detects an input voltage above the set limit, it will put the motor into a hard brake until the voltage drops below the set point again. This is inefficient, because the energy is heating the motor instead of recharging a battery, but may be necessary. The driver comes preset for a maximum voltage of 30V. The range for a custom maximum voltage is 0v-25v. The formula for setting a custom maximum voltage is

$$\text{Value} = \text{Desired Volts} \times 5.12$$

If you are using any sort of battery, then this is not a problem and the max voltage should be left at the startup default.

### **4: Drive forward motor 2 (decimal 4, binary 0b00000100, hex 0h04)**

This is used to command motor 2 to drive forward. Valid data is 0-127 for off to full forward drive. If a command of 0 is given, the Sabertooth will go into power save mode for motor 2 after approximately 4 seconds.

### **5: Drive backwards motor 2 (decimal 5, binary 0b00000101, hex 0h05)**

This is used to command motor 2 to drive backwards. Valid data is 0-127 for off to full reverse drive. If a command of 0 is given, the Sabertooth will go into power save mode after approximately 4 seconds.

### **6: Drive motor 1 7 bit (decimal 6, binary 0b00000110, hex 0h06)**

This command is used to drive motor 1. Instead of the standard commands 0 and 1, this one command can be used to drive motor 1 forward or in reverse, at a cost of lower resolution. A command of 0 will correspond to full reverse, and a command of 127 will command the motor to drive full forward. A command of 64 will stop the motor.

### **7: Drive motor 2 7 bit (decimal 7, binary 0b00000111, hex 0h07)**

This command is used to drive motor 2. Instead of the standard commands 4 and 5, this one command can be used to drive motor 1 forward or in reverse, at a cost of lower resolution. A command of 0 will correspond to full reverse, and a command of 127 will command the motor to drive full forward. A command of 64 will stop the motor.

## Mixed mode commands:

---

Sabertooth can also be sent mixed drive and turn commands. When using the mixed mode commands, please note that the Sabertooth requires valid data for both drive and turn before it will begin to operate. Once data for both has been sent, then each may be updated as needed, it is not necessary to send both data packets each time you wish to update the speed or direction. You should design your code to either use the independent or the mixed commands. Switching between the command sets will cause the vehicle to stop until new data is sent for both motors.

### **8: Drive forward mixed mode (decimal 8, binary 0b00001000, hex 0h08)**

This is used to command the vehicle to drive forward in mixed mode. Valid data is 0-127 for off to full forward drive.

### **9: Drive backwards mixed mode (decimal 9, binary 0b00001001, hex 0h09)**

This is used to command the vehicle to drive backwards in mixed mode. Valid data is 0-127 for off to full reverse drive.

### **10: Turn right mixed mode (decimal 10, binary 0b00001010, hex 0h0a)**

This is used to command the vehicle to turn right in mixed mode. Valid data is 0-127 for zero to maximum turning speed.

### **11: Drive turn left mixed mode (decimal 11, binary 0b00001011, hex 0h0b)**

This is used to command the vehicle to turn left in mixed mode. Valid data is 0-127 for zero to maximum turning speed.

### **12: Drive forwards/back 7 bit (decimal 12, binary 0b00001100, hex 0h0c)**

This is used to command the vehicle to move forwards or backwards. A command of 0 will cause maximum reverse, 64 will cause the vehicle to stop, and 127 will command full forward.

### **13: Turn 7 bit (decimal 13, binary 0b00001101, hex 0h0d)**

This is used to command the vehicle turn right or left. A command of 0 will cause maximum left turn rate, 64 will cause the vehicle to stop turning, and 127 will command maximum right turn rate.



# Setting Commands

---

Several parameters of the Sabertooth 2x25 can be changed using Packetized Serial mode. Some of these changes persist when the unit is powercycled and some persist when it is switched to other modes.

## **14: Serial Timeout (decimal 14, binary 0b00001110, hex 0h0e)**

This setting determines how long it takes for the motor driver to shut off if it has not received a command recently. Serial Timeout is off by default. A command of 0 will disable the timeout if you had previously enabled it. The timeout scales 1 unit per 100ms of timeout, so a command of 10 would make a timeout of 1000ms. This setting does **not** persist through a power cycle or in any mode other than packet Serial.

## **15: Baud Rate (decimal 15, binary 0b00001111, hex 0h0f)**

This value remains until it is changed and does persist through a power cycle. The values are:

- 1: 2400 baud
- 2: 9600 baud (default)
- 3: 19200 baud
- 4: 38400 baud

## **16: Ramping (decimal 16, binary 0b00010000, hex 0h10)**

This adjusts or disables the ramping feature found on the Sabertooth 2x25. This adjustment applies to all modes, even R/C and analog mode. Values between 1 and 10 are **Fast Ramp**; values between 11 and 20 are **Slow Ramp**; values between 21 and 80 are **Intermediate Ramp**. **Fast Ramping** is a ramp time of  $256/(\sim 1000 \times \text{Command value})$ . Ramp time is the delay between full forward and full reverse speed.

- 1: 1/4 second ramp (default)
- 2: 1/8 second ramp
- 3: 1/12 second ramp

**Slow and Intermediate Ramping** are a ramp time of  $256/[15.25 \times (\text{Command value} - 10)]$

See **Figures 8.1 and 8.2** in the Appendix for a graph of values.

## **17: Deadband (decimal 17, binary 0b00010001, hex 0h11)**

This determines the extent of the Sabertooth's deadband – the range of commands close to “stop” that will be interpreted as stop. This setting applies to all modes and persists through a power cycle. The commands range from 0 to 127 and the formula is as follows:

$127 - \text{command} < \text{motors off} < 128 + \text{command}$

Thus, a command of 3 would shut the motors off with speed commands between 124 and 131.

A command of 0 sets the deadband to its default, which is  $124 < \text{off} < 131$  in serial mode.

## Checksum:

---

To prevent data corruption, each packet is terminated with a checksum. If the checksum is not correct, the data packet will not be acted upon. The checksum is calculated as follows:

Checksum = address byte +command byte +data byte

The checksum should be added with all unsigned 8 bit integers, and then ANDed with the mask 0b01111111 in an 8 bit system.

## Example of Packetized Serial:

---

The following is an example function for commanding two Dimension Engineering motor drivers using Packetized Serial Mode. **Figure 7.3** shows an example hookup and **Figure 7.4** shows an example function.

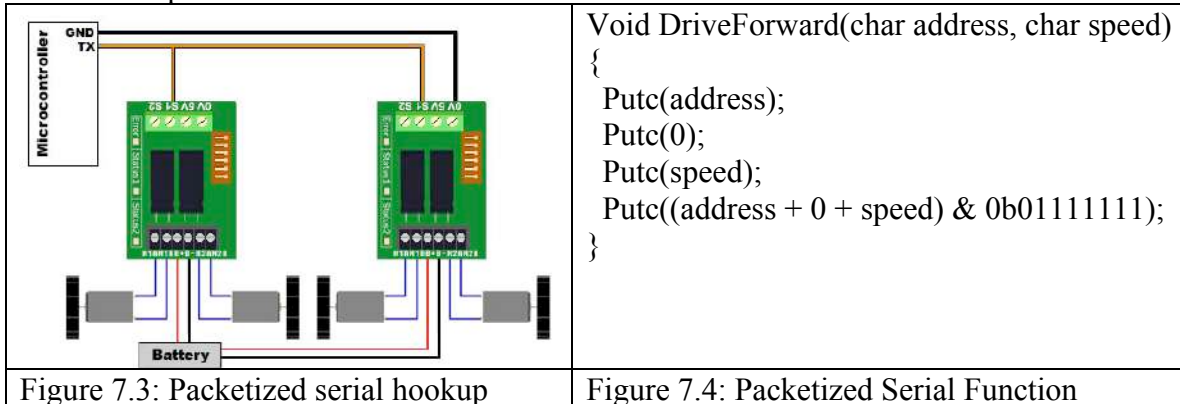

Example: So in this function, if address is 130, command is 0 (for driving forward), speed is 64, the checksum should calculate as follows:

$$130+0+64 = 194$$

194 in binary is 0b11000010

$$0b11000010 \& 0b01111111 = 0b01000010$$

Once all the data is sent, this will result in the Sabertooth with address 130 driving forward at roughly half throttle.

## Emergency Stop:

---

In Packetized Serial mode, the S2 input is configured as an active-low emergency stop. It is pulled high internally, so if this feature isn't needed, it can be ignored. If an emergency stop is desired, all the S2 inputs can be tied together. Pulling the S2 input low will cause the driver to shut down. This should be tied to an emergency stop button if used in a device that could endanger humans.

# DEscribe Software:

The Sabertooth 2x25V2 motor controller can interface with our DEscribe software. This software package will allow the end user to change a lot about how the controller behaves both on the input and output sides.

Features:

- Modify the throttle curve map

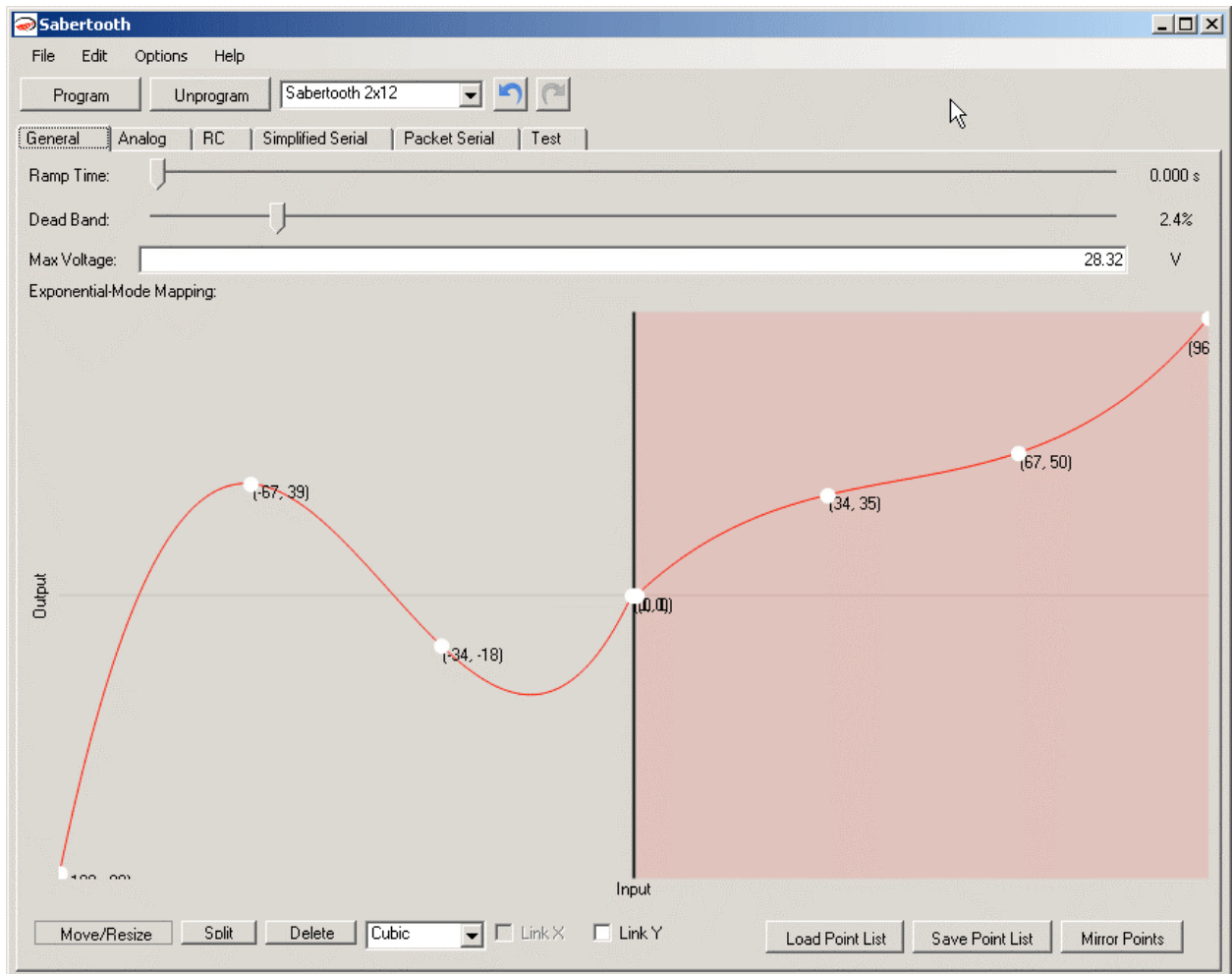

- Adjust Ramp Time
- Adjust Dead Band
- Change analog voltage input center and range
- Change servo pulse timings in RC mode
  - Perfect when a smaller or larger range is optimal
- Adjust timeout length in RC mode
- Set simple serial mode to use custom throttle curves
- Set baud rate with one drop-down box

All of these features can be programmed to a compatible motor controller via a USB link. DEscribe also has the option to download the current setup from a connected driver back to the software. There are options to save and open custom configurations within the software. This software can also be used to batch program compatible drivers for custom setups.

# Appendix

**Figure 8.1: Fast and Intermediate Ramp**

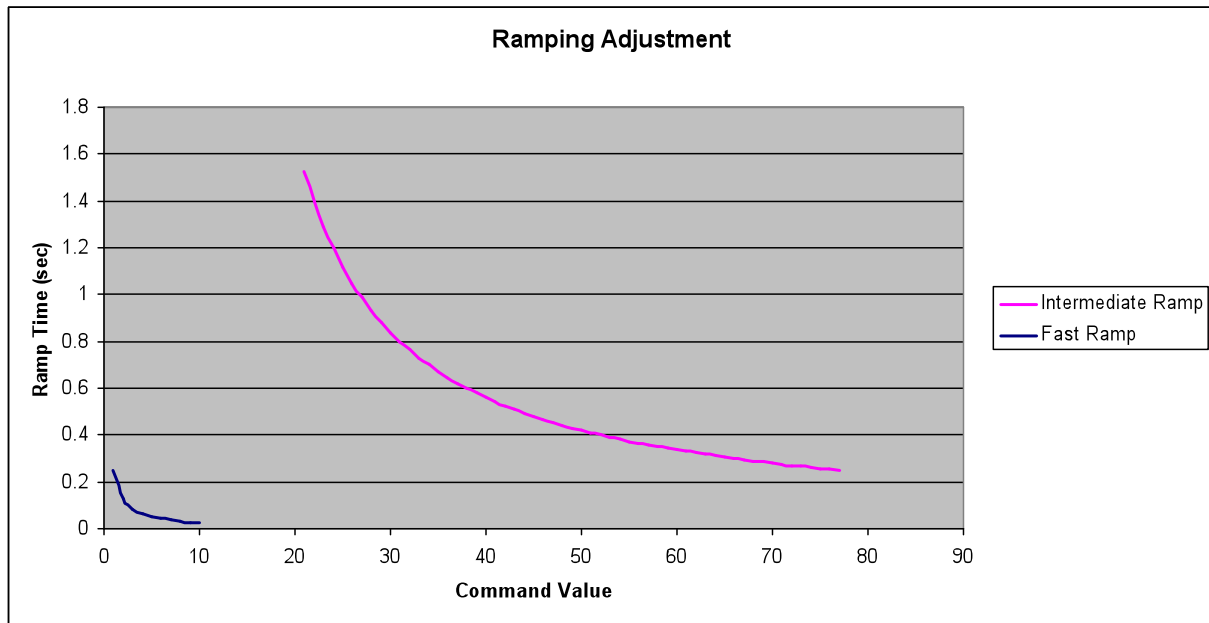

**Figure 8.2: Slow Ramp**

